

Radio Interferometry Basics

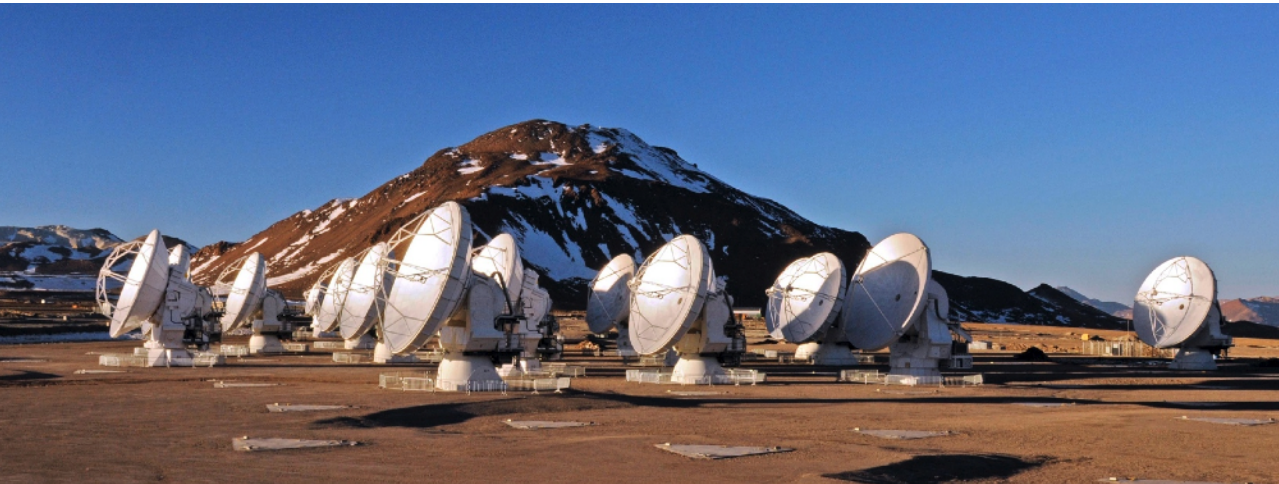

Emily Moravec

**Authors: Alison Peck, Jim Braatz,
Ashley Bemis, Sabrina Stierwalt**



Radio Astronomy

Now used to refer to most telescopes using heterodyne technology

THE ELECTROMAGNETIC SPECTRUM

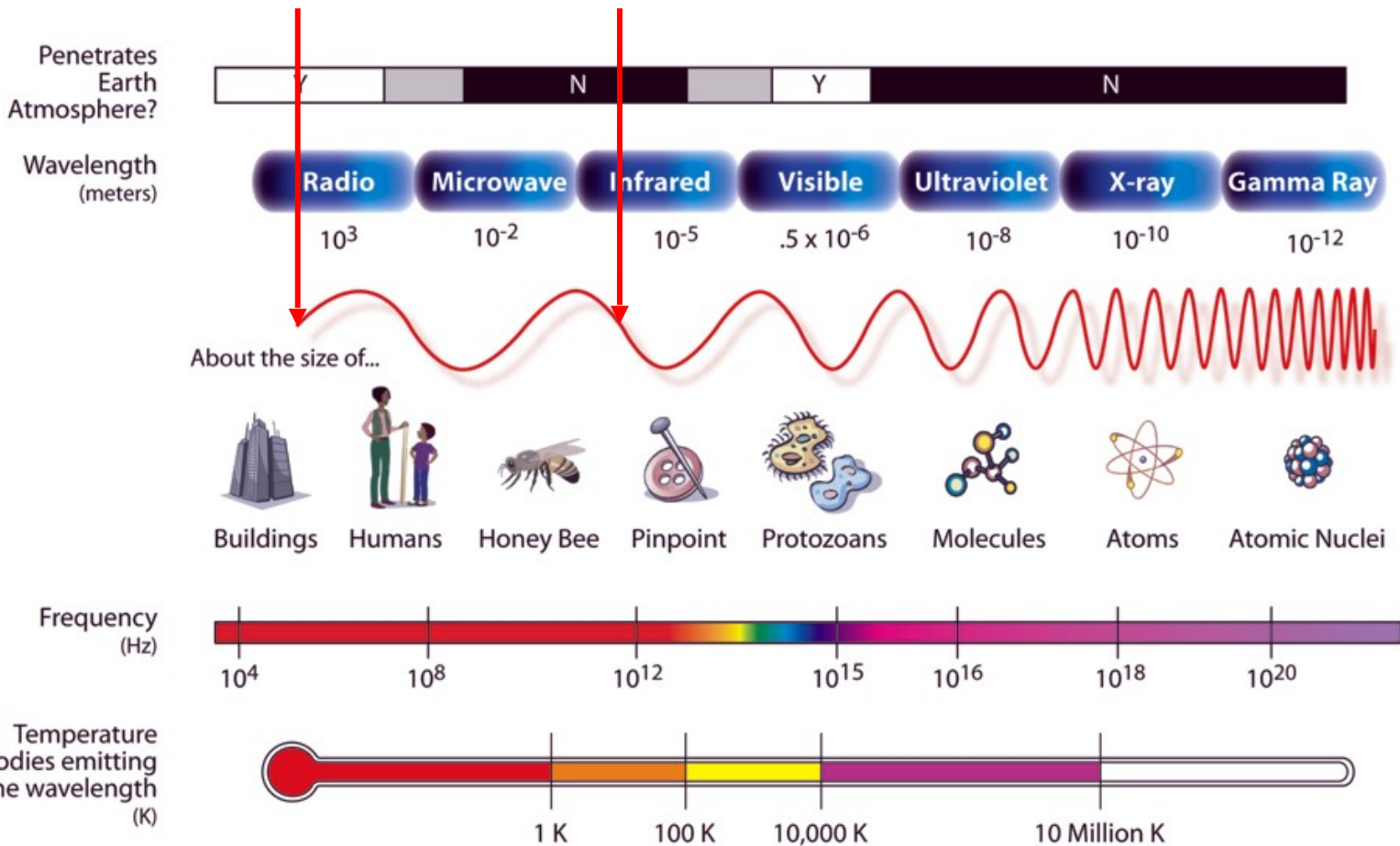

What is heterodyne?

In a heterodyne receiver, observed sky frequencies are converted to lower frequency signals by mixing with a signal artificially created by a Local Oscillator. The output can then be amplified and analyzed more easily while retaining the original phase and amplitude information.

**Synoptic diagram of heterodyne receivers
(basic building blocks)**

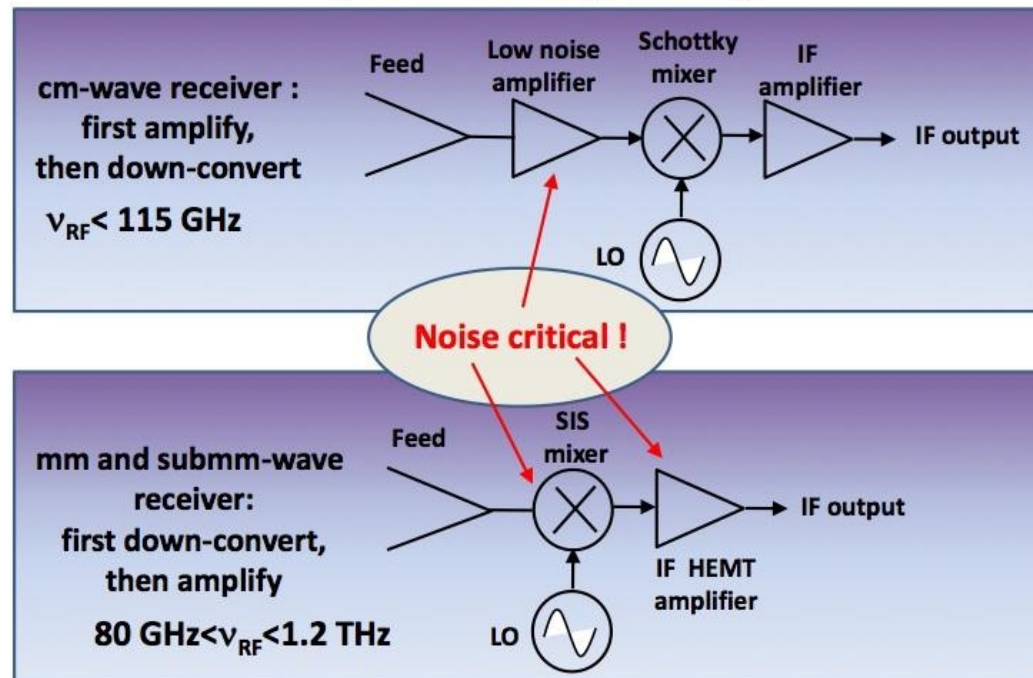

Image from
Alessandro Navarrini
(IRAM)

Long wavelength means no glass mirrors



What can we observe? (MHz-GHz range)

Jupiter's radiation belt at 100MHz

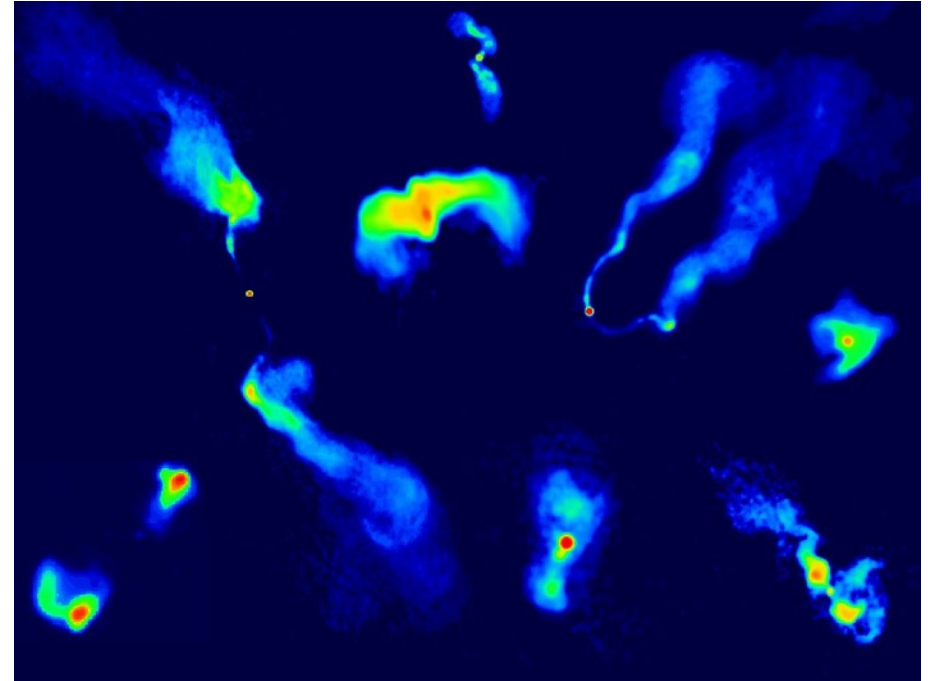
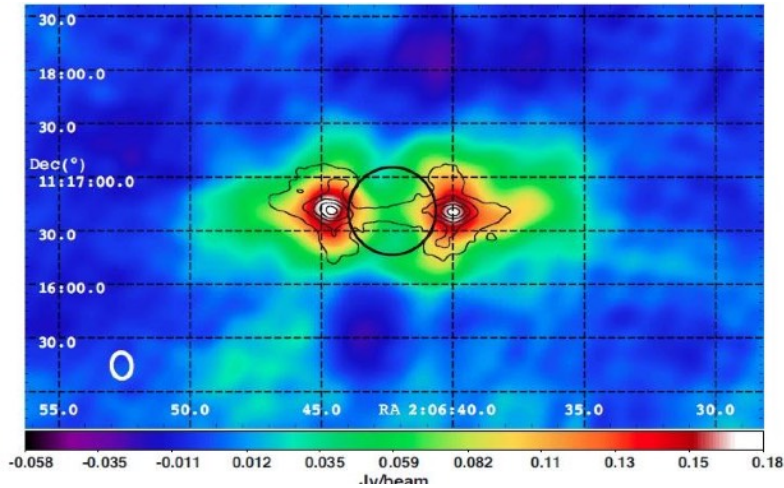

Relic emission from old radio galaxies

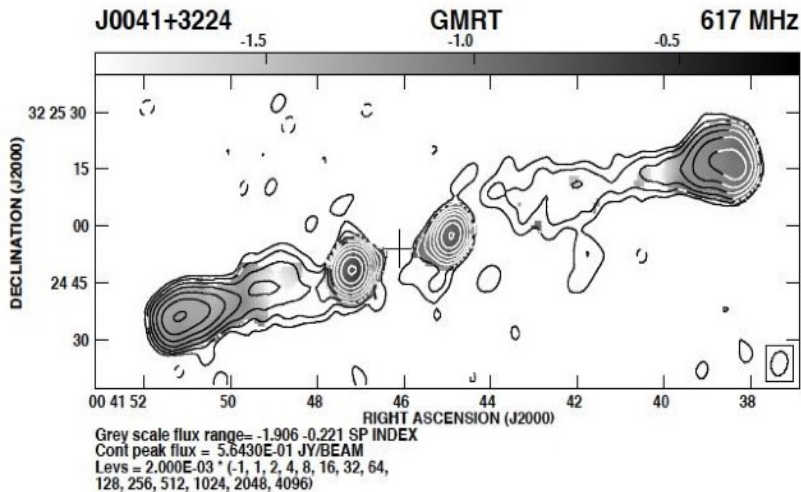

Synchrotron emission from extended radio galaxies (5 GHz)

What can we observe?

At low frequencies (MHz-GHz):

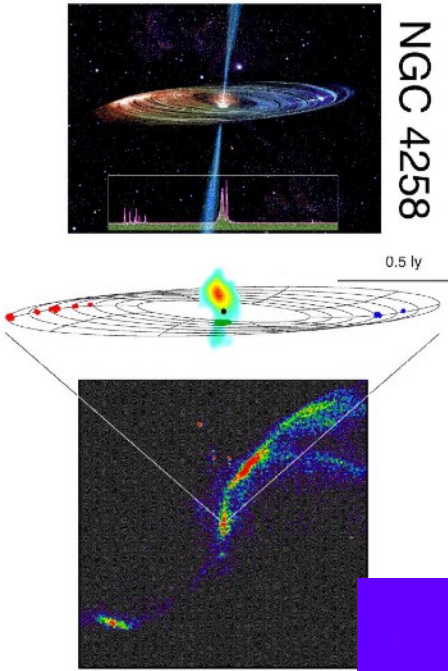

NGC 4258

0.5 ly

H₂O, OH or SiO masers in galaxies and stars

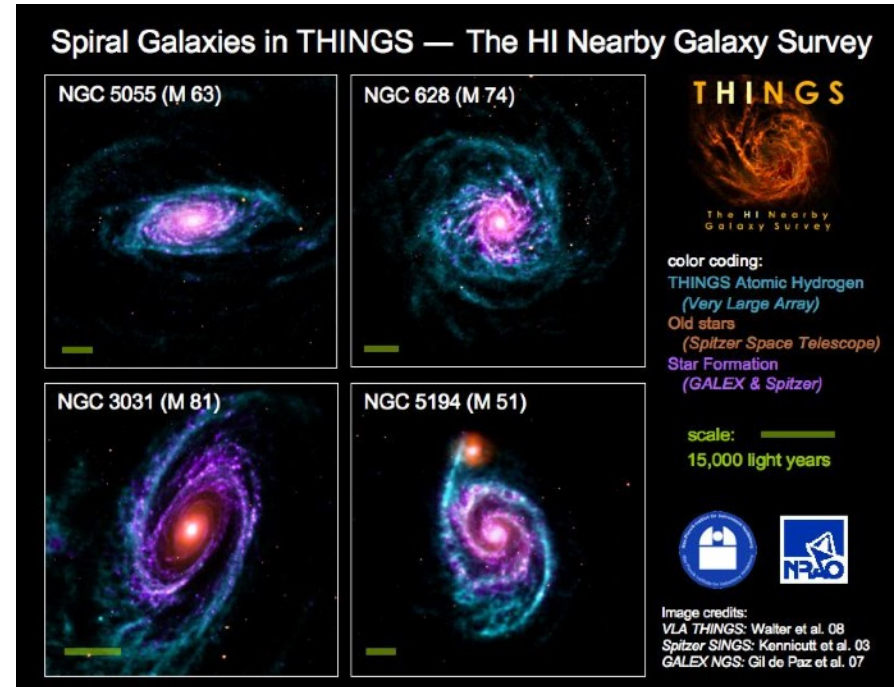

HI emission and absorption, free-free absorption in galaxies

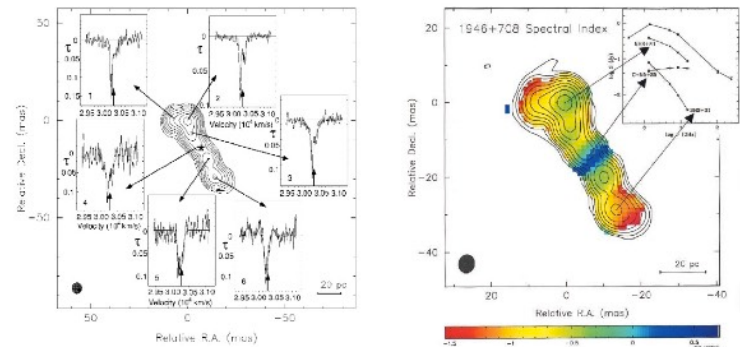

2/13/23

What can we observe?

At higher frequencies we can observe a broad range of molecular lines

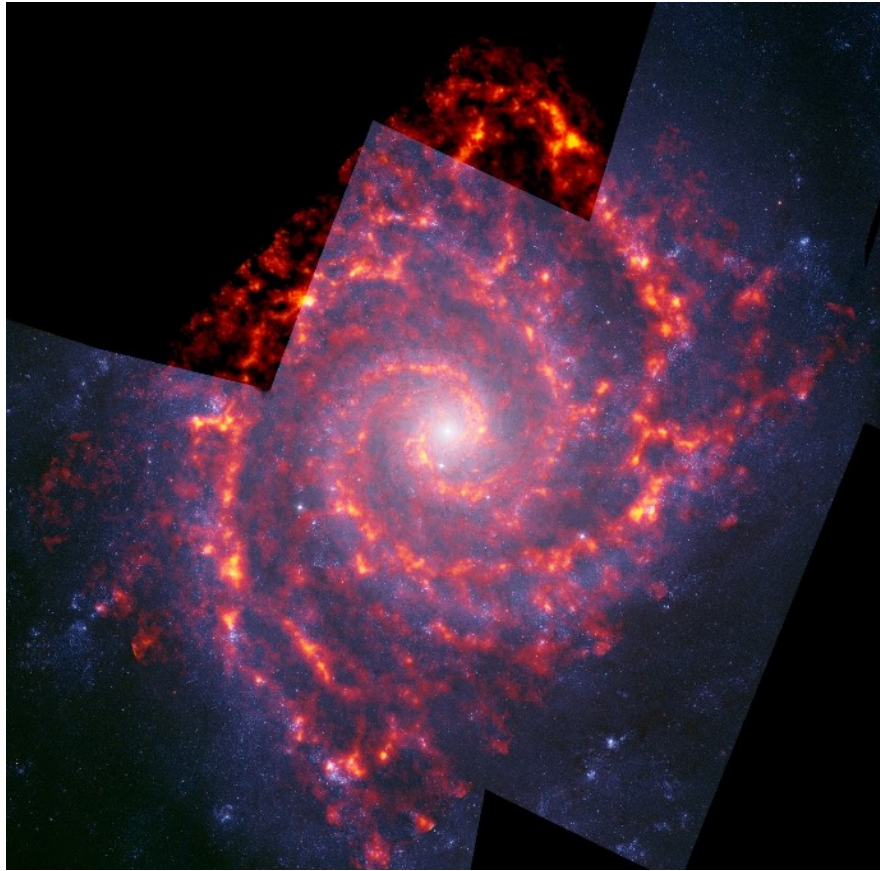

NRAO/AUI/NSF, B. Saxton: ALMA (ESO/NAOJ/NRAO); NASA/Hubble

Resolution of Observations

Angular resolution for most telescopes is $\sim \lambda/D$

D is the diameter of the telescope and λ is the wavelength of observation

For the Hubble Space Telescope:

$\lambda \sim 1\mu\text{m} / D \text{ of } 2.4\text{m} = \text{resolution} \sim 0.13''$

**To reach that resolution at $\lambda \sim 1\text{mm}$, we would need a
2 km-diameter dish!**

Instead, we use arrays of smaller dishes to achieve the same high angular resolution at radio frequencies

This is interferometry!



What is an interferometer?

An *interferometer* measures the interference pattern produced by multiple apertures, much like a 2-slit experiment

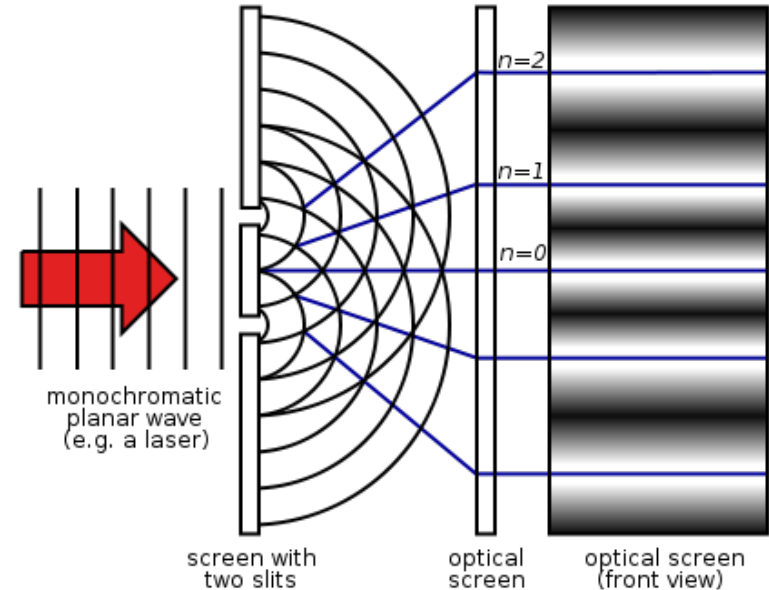

However, the interference patterns measured by radio telescopes are produced by **multiplying - not adding - the wave signals measured at the different telescopes (i.e. apertures)*

Also see "An Introduction to Radio Interferometry"
<https://www.youtube.com/watch?v=NWARvPvPF-Q>

How Do We Use Interferometry?

Signal arrives at each antenna at a different time (due to different travel lengths) depending on the location of the antenna in the array

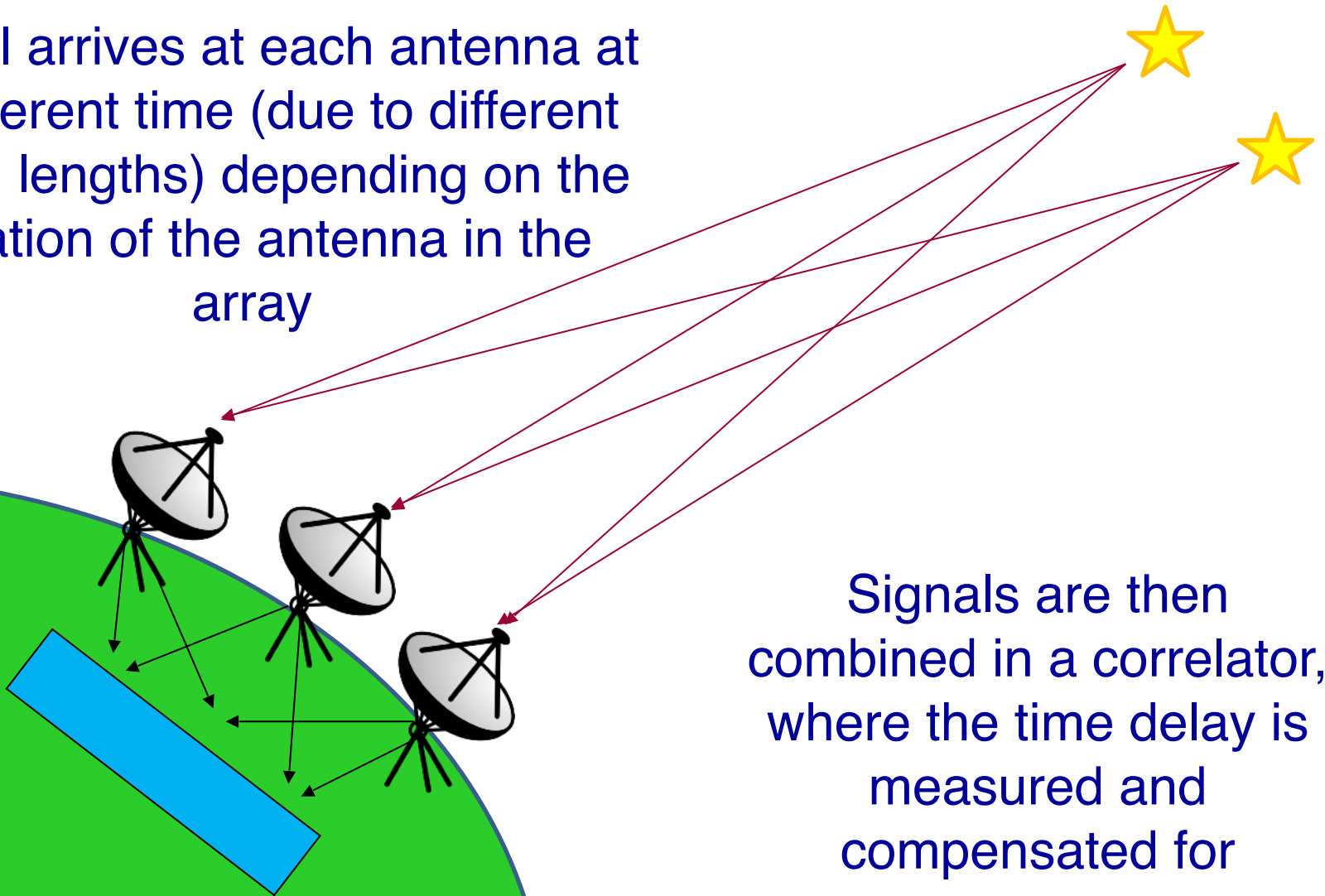

Signals are then combined in a correlator, where the time delay is measured and compensated for

Some Instrument Details

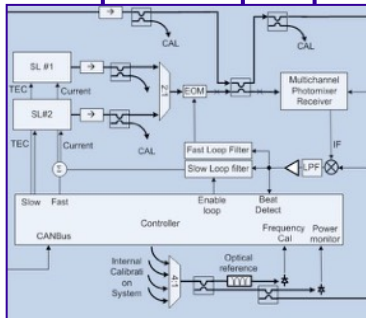

To precisely measure arrival times we need very accurate clocks

At Band 10 one wavelength error = 1 picosecond = 10^{-12} s (!!)

Need \ll 1 wavelength timing precision, so each antenna has an on-board clock with high sampling rates

Once determined, the reference time is distributed to all antennas

Some Instrument Details

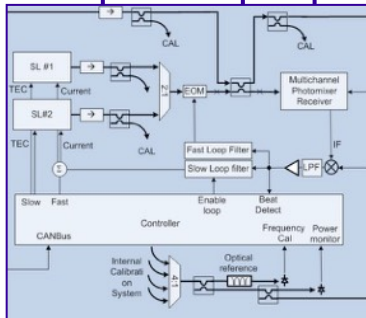

Signals from each antenna are digitized and sent to the correlator for multiplication & averaging

For ~50 antennas, the data rate is 600 GB/sec for the correlator to process



An Interferometer In Action

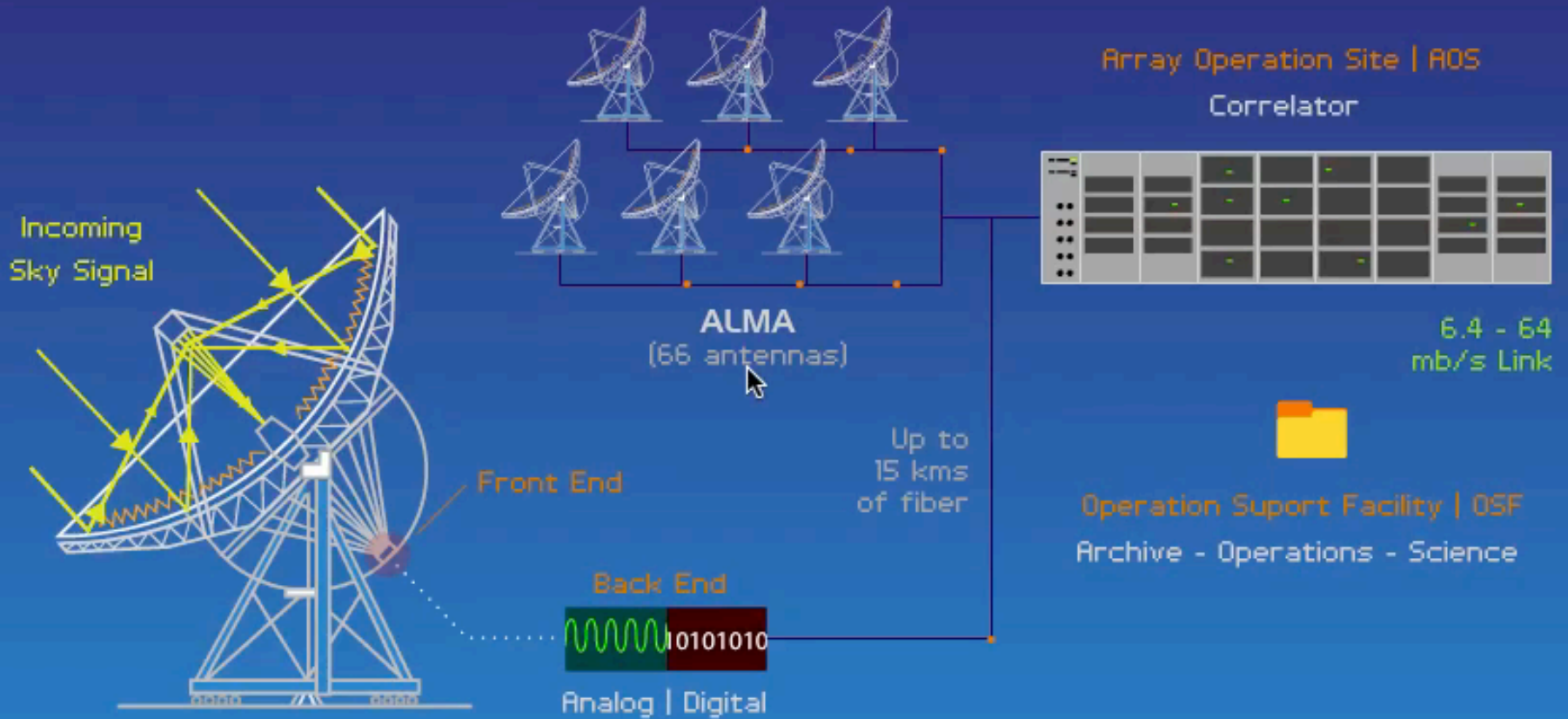

Introducing the Fourier Transform

Fourier theory states that any well behaved signal (including images) can be expressed as the sum of sinusoids

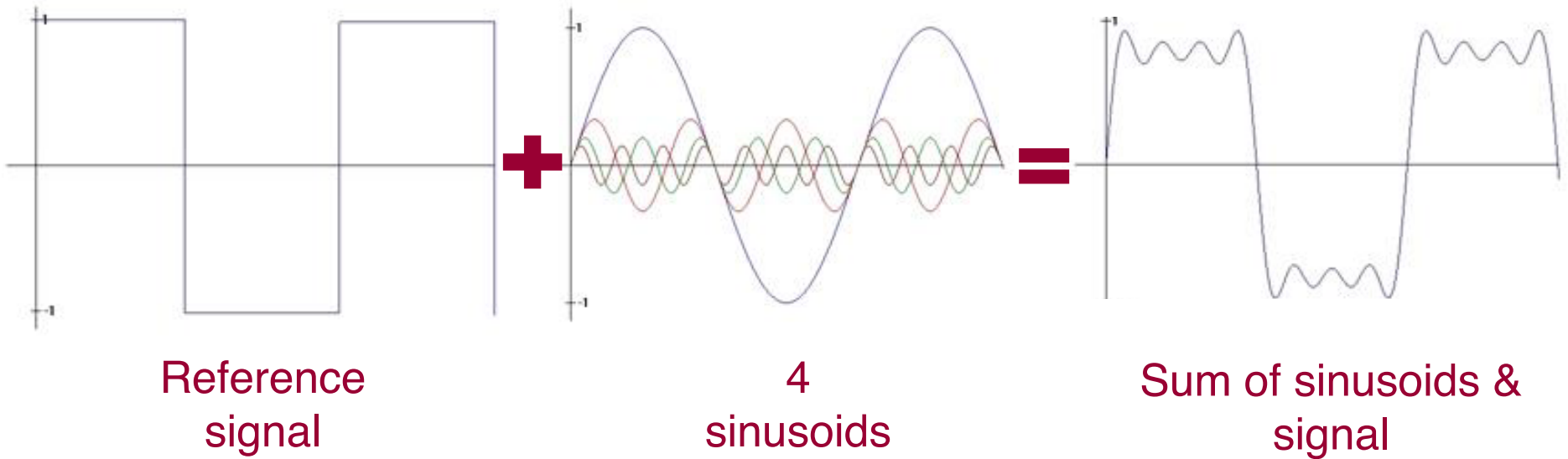

The Fourier transform is the mathematical tool that decomposes a signal into its sinusoidal components

The Fourier transform contains *all* of the information of the original signal

Visibility and Sky Brightness

The van Cittert-Zernike theorem

Visibility as a function of baseline coordinates (u,v) is the Fourier transform of the sky brightness distribution as a function of the sky coordinates (x,y)

$$V(u, v) \xrightarrow{\text{FT}} T(x, y)$$

$V(u,v)$ = the complex visibility function = $\iint T(x, y) e^{2\pi i(ux+vy)} dx dy$

$T(x,y)$ = the sky brightness distribution = $\iint V(u, v) e^{-2\pi i(ux+vy)} du dv$

The Fourier Transform relates the measured interference pattern to the radio intensity on the sky

Fourier space/domain

$$V(u, v) = \iint T(x, y) e^{2\pi i(ux+vy)} dx dy$$

Image space/domain

$$T(x, y) = \iint V(u, v) e^{-2\pi i(ux+vy)} du dv$$

(for more info, see e.g.
Thompson, Moran & Swenson)

image
plane

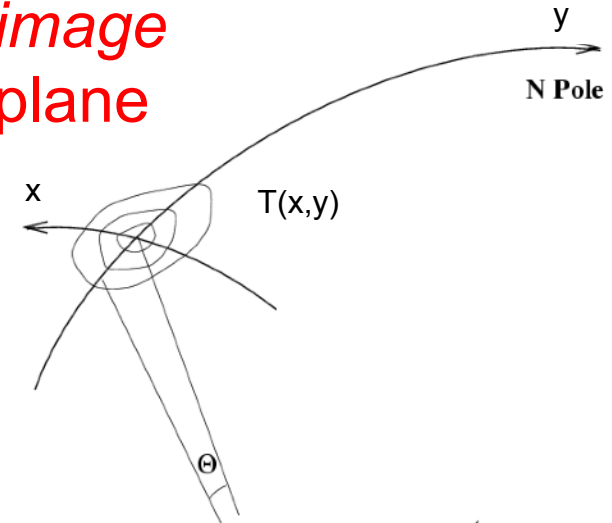

uv
plane

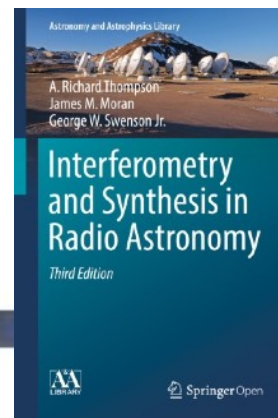
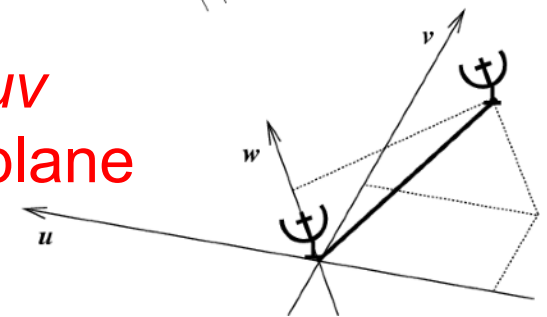

What Are Visibilities?

Each $V(u,v)$ contains information on $T(x,y)$ everywhere

Each $V(u,v)$ is a complex quantity

Expressed as (real, imaginary) or (amplitude, phase)



$T(x,y)$

FT
→

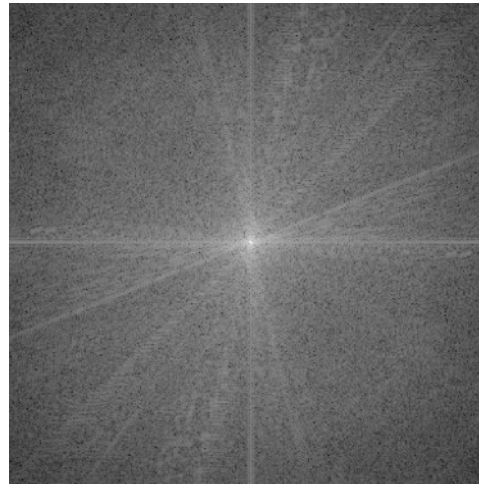

$V(u,v)$ amplitude

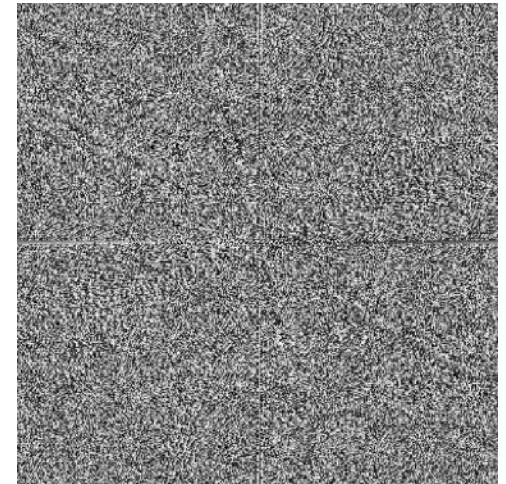

$V(u,v)$ phase

Examples of 2D Fourier Transforms

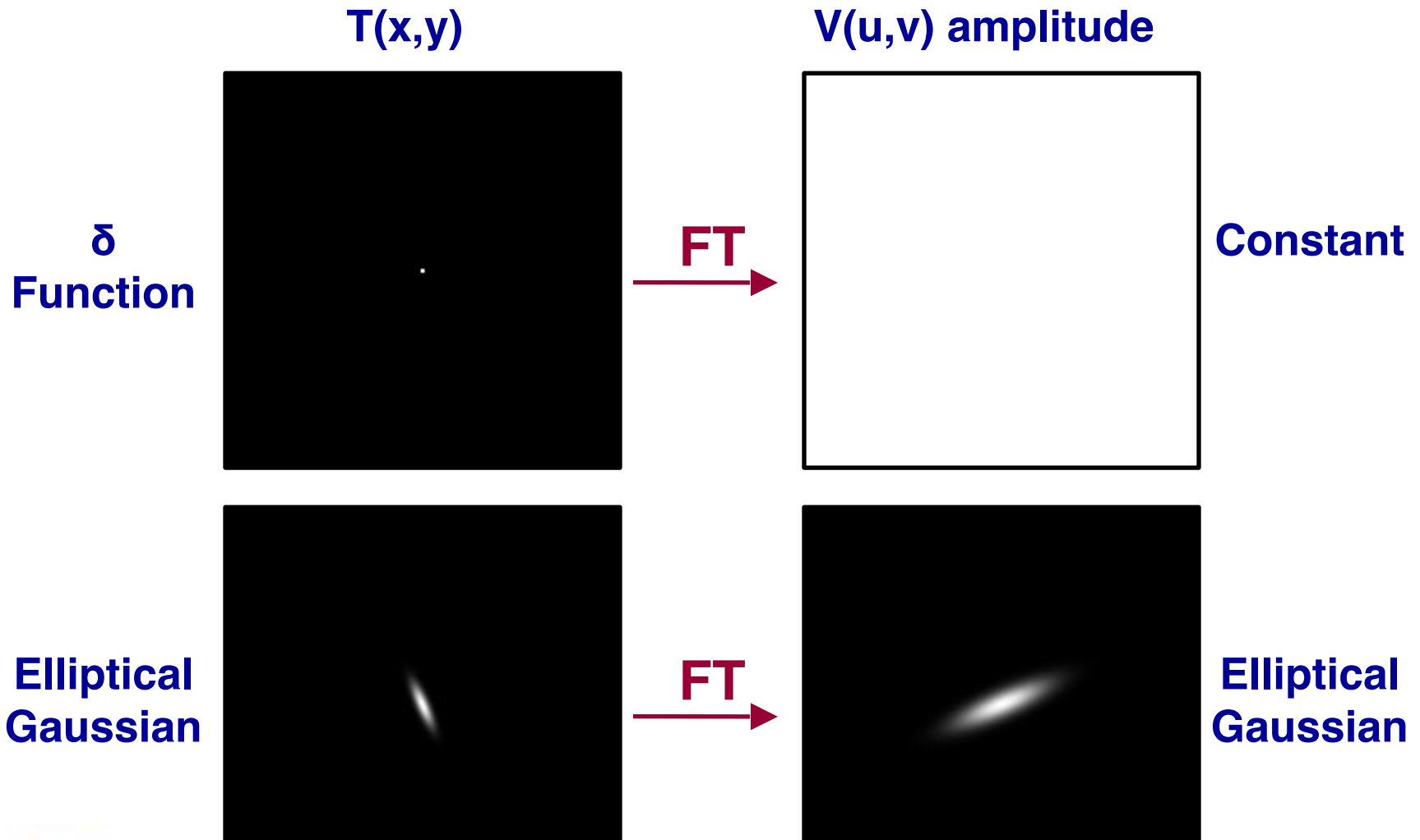

Rules of the Fourier Transform:

Narrow features transform to wide features (and vice versa)

Examples of 2D Fourier Transforms

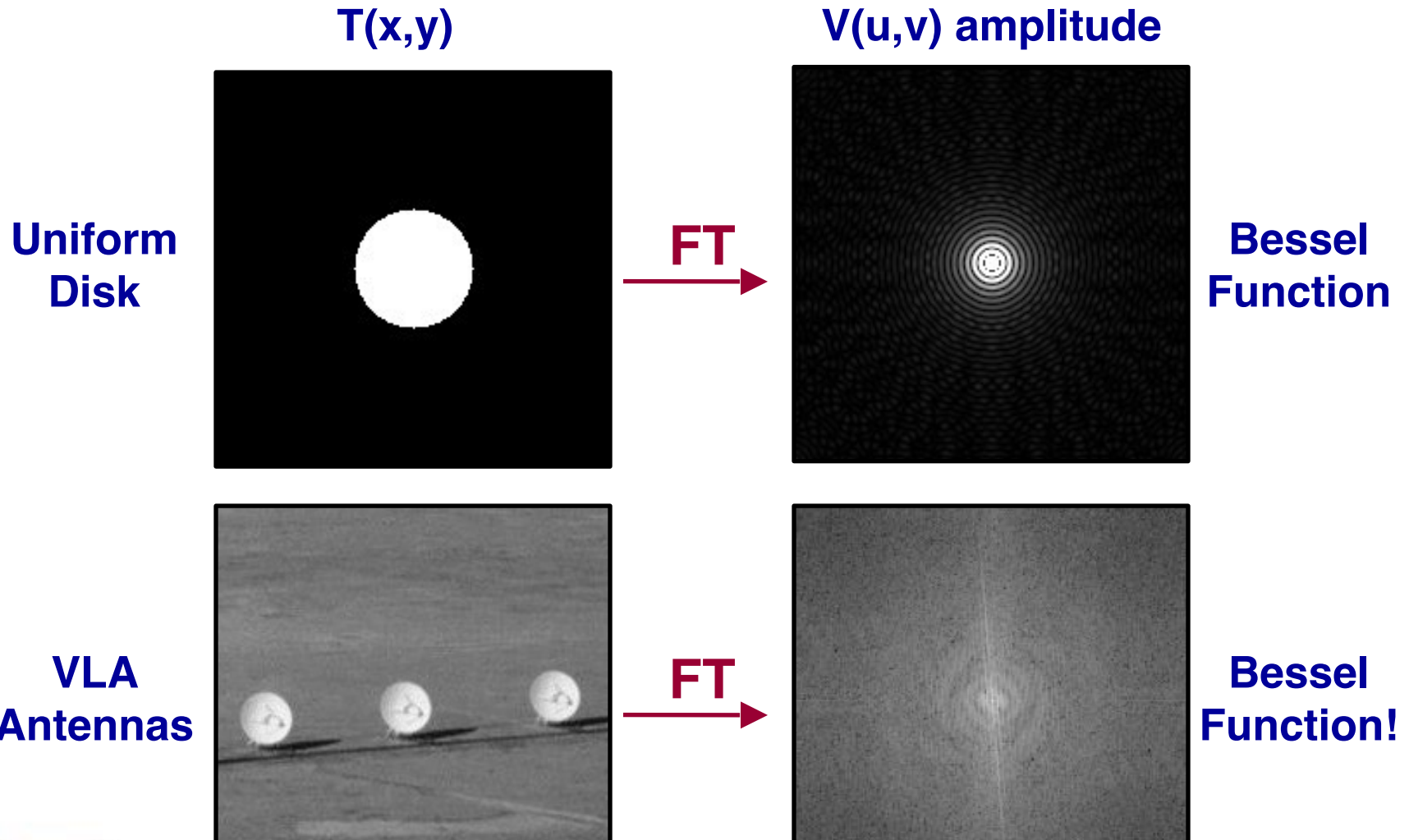

Rules of the Fourier Transform:
Sharp features (edges) result in many high spatial features

Examples of 2D Fourier Transforms

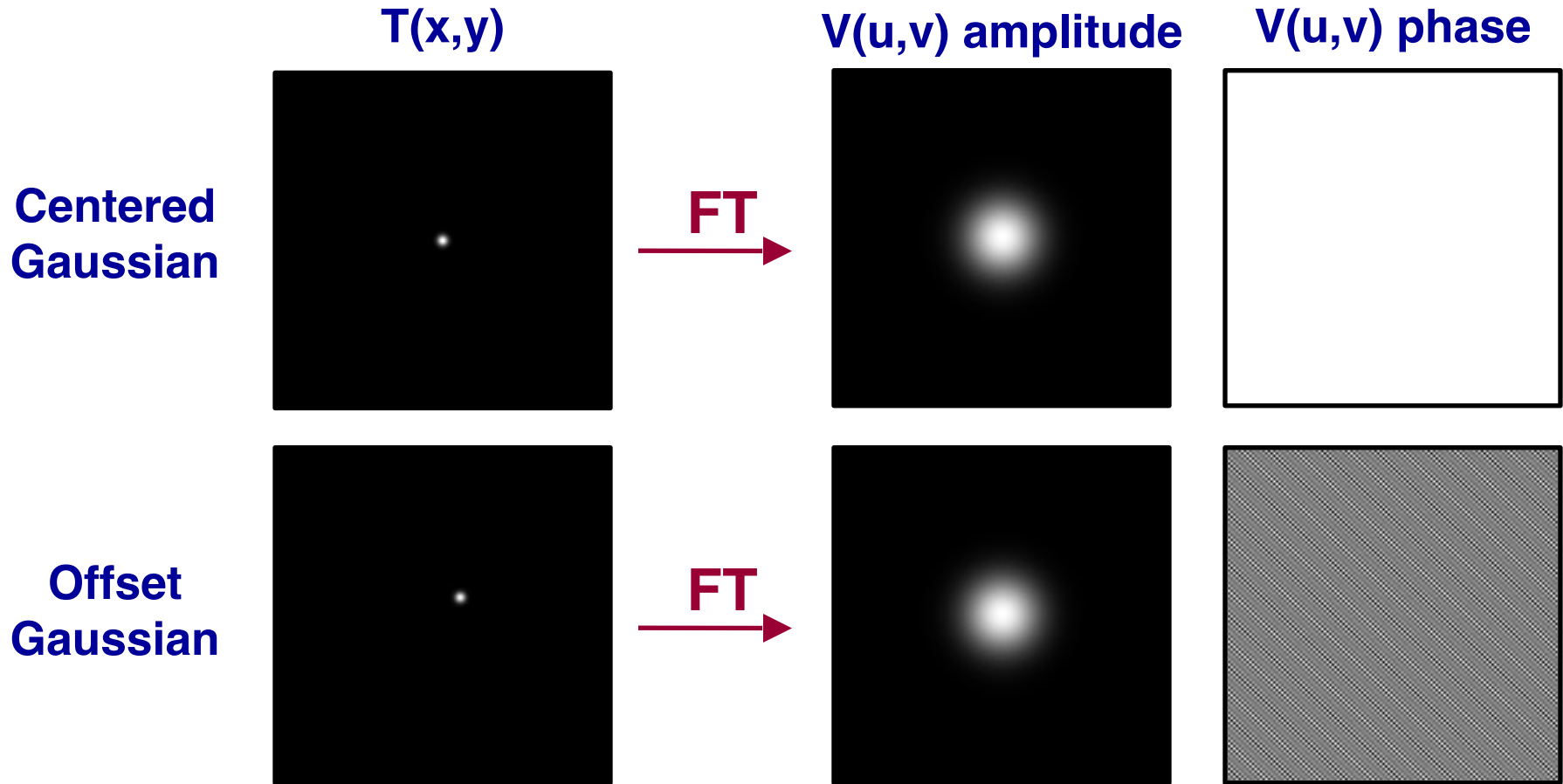

Rules of the Fourier Transform:

Amplitude tells you 'how much' of a spatial frequency

Phase tells you 'where' the spatial frequency is

Visibility and Sky Brightness

Graphic courtesy Andrea Isella

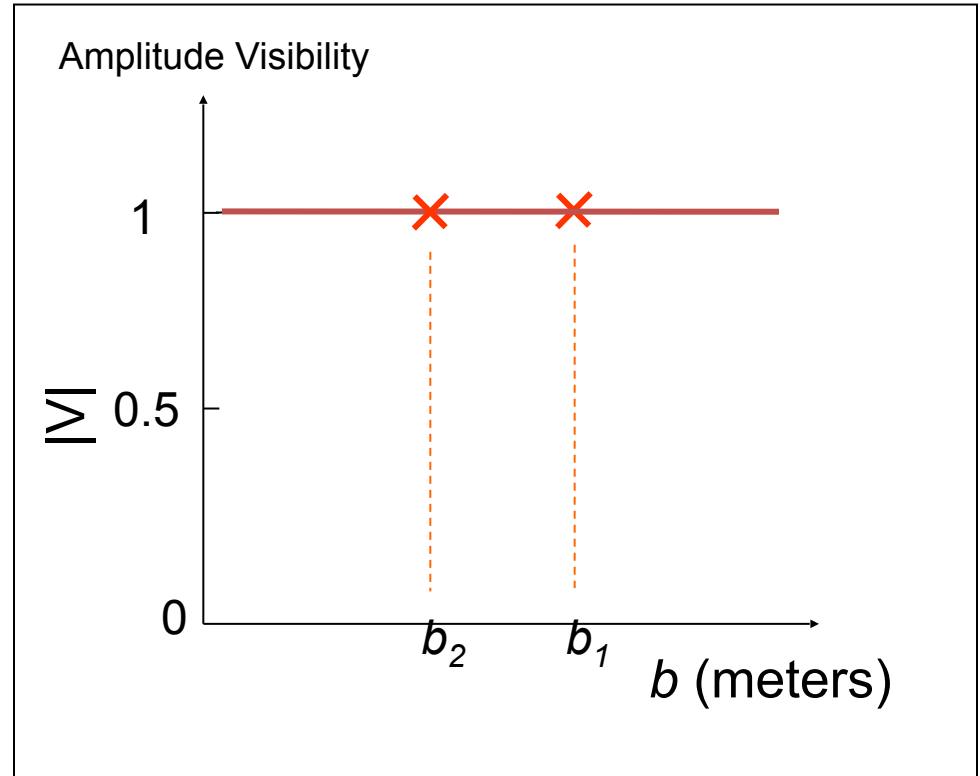
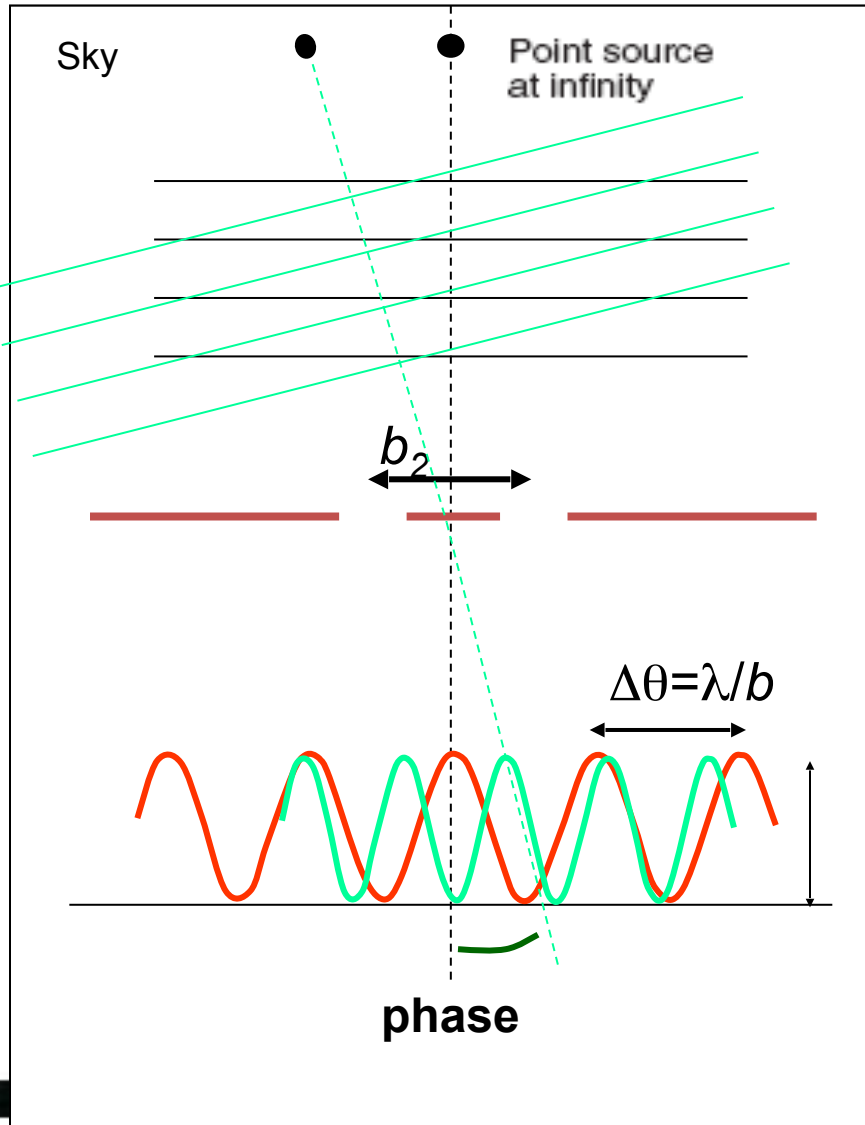

- The visibility is a **complex** quantity:
- **amplitude** tells “how much” of a certain frequency component
 - **phase** tells “where” this component is located

Visibility and Sky Brightness

Graphic courtesy Andrea Isella

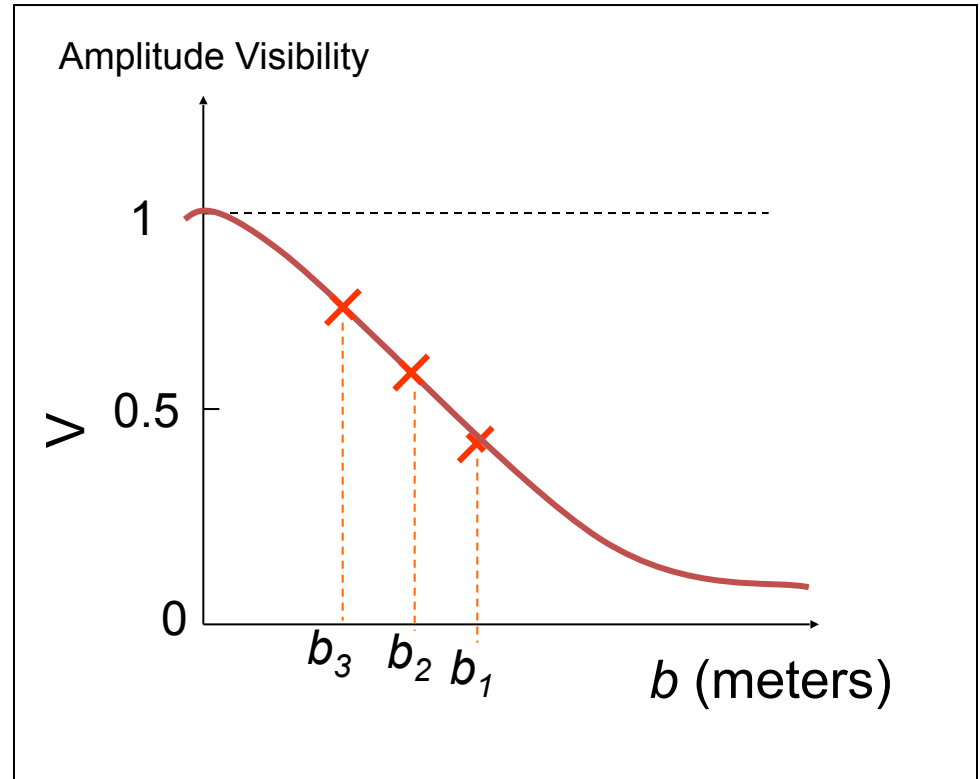
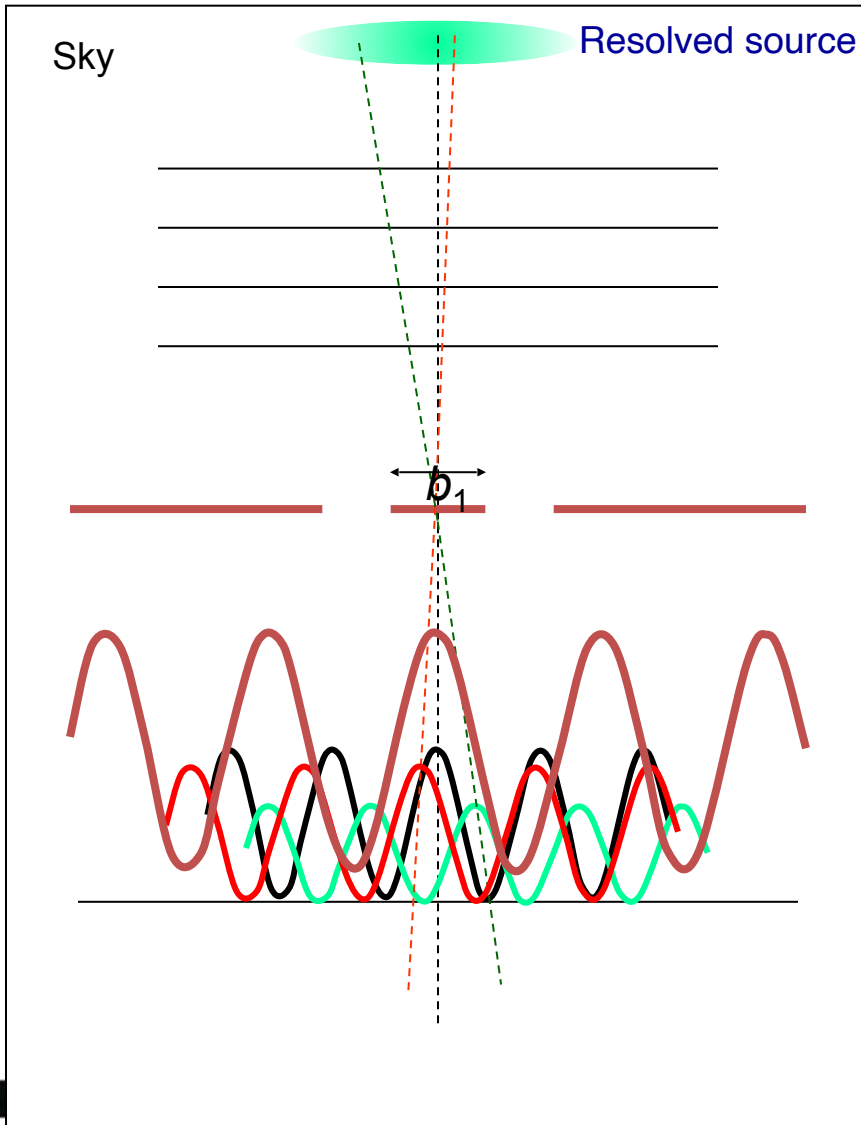

Basics of Aperture Synthesis

Idea: Sample $V(u,v)$ at an enough (u,v) points using distributed small aperture antennas to synthesize a large aperture antenna of size (u_{\max}, v_{\max})

One pair of antennas = one baseline

For **N antennas**, we get **$N(N-1)$ samples** at a time

How do we fill in the rest of the (u,v) plane?

1. Earth's rotation
2. Reconfigure physical layout of N antennas



One baseline = 2 (u,v) points (complex numbers)



(u,v) Plane Sampling

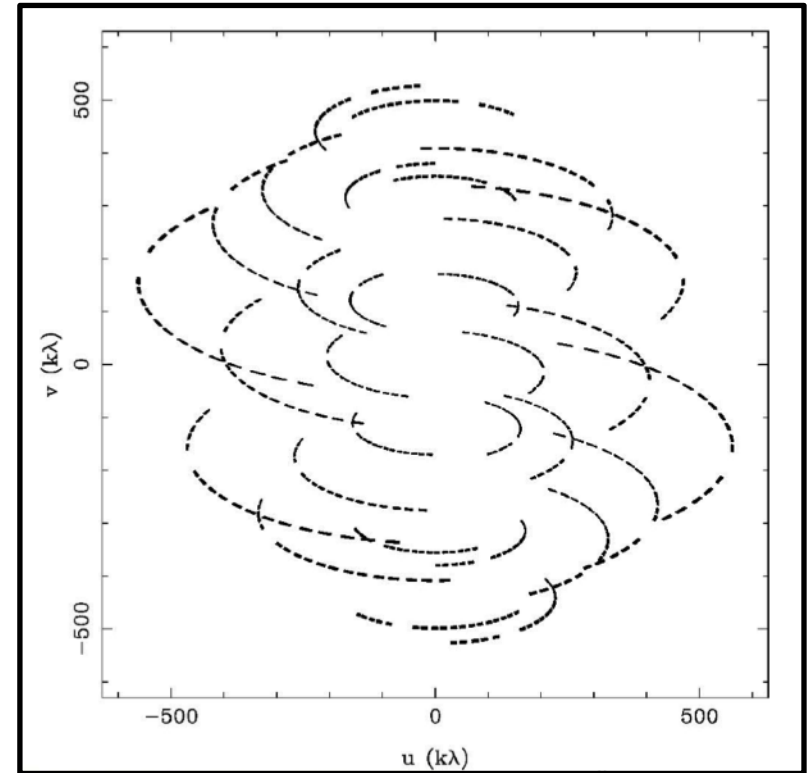
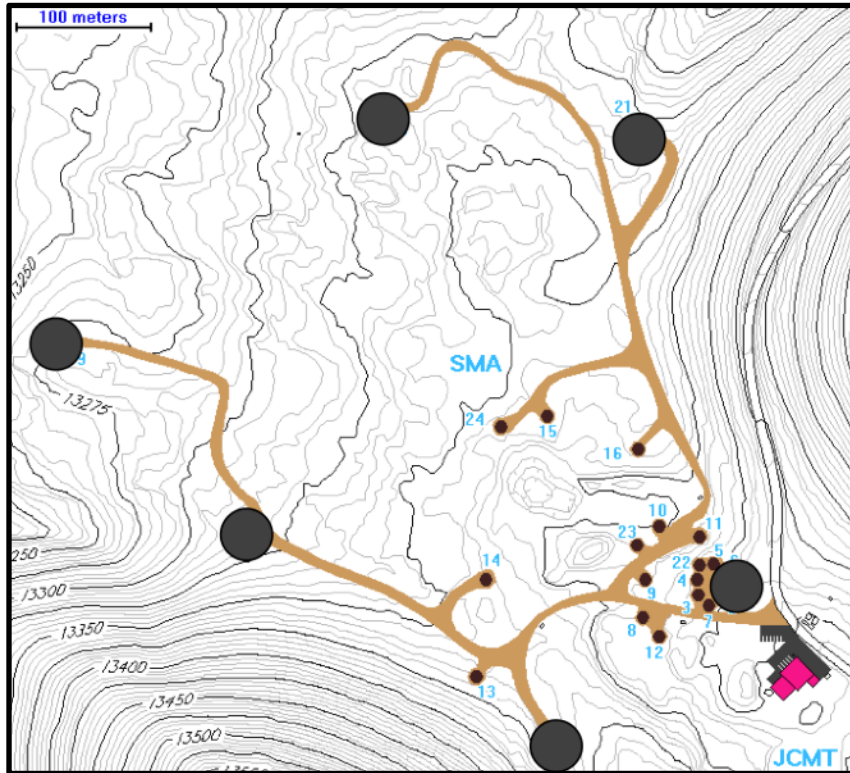

Very Extended SMA configuration
(most extended baselines)
345 GHz, DEC = +22

(u,v) Plane Sampling

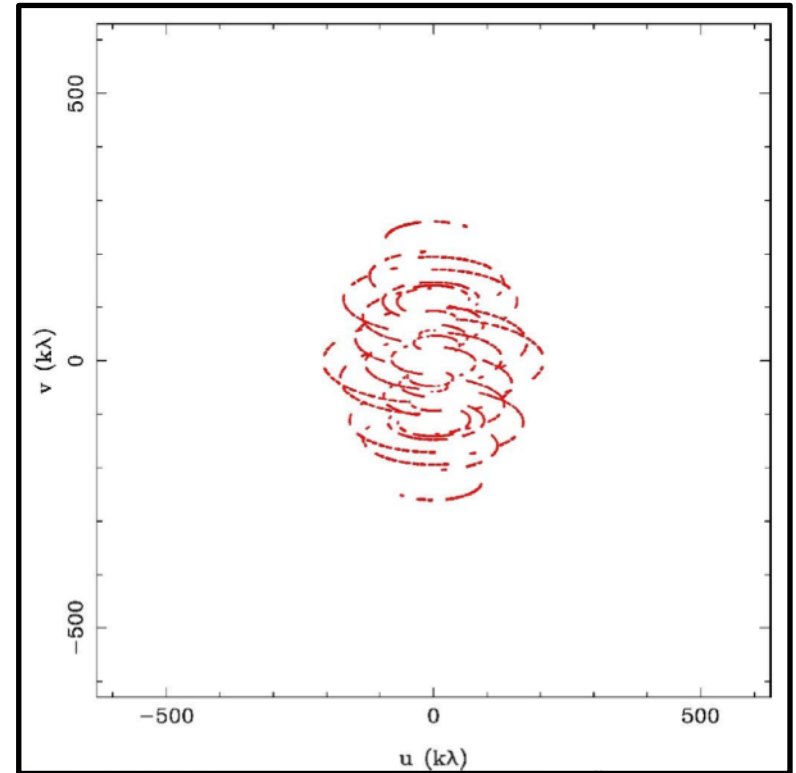
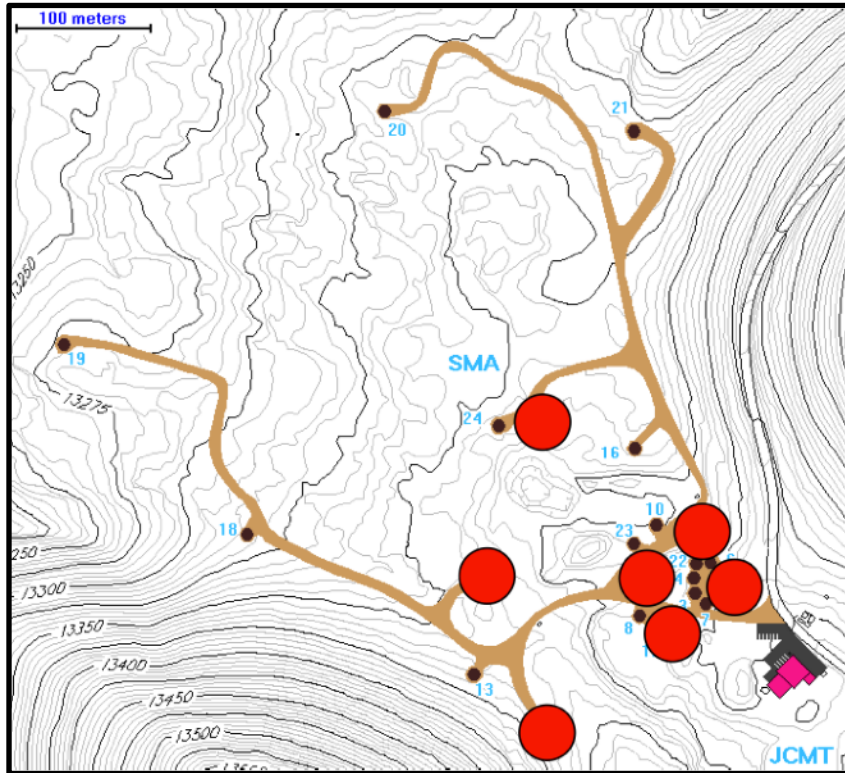

Extended SMA configuration

(extended baselines)

345 GHz, DEC = +22

(u,v) Plane Sampling

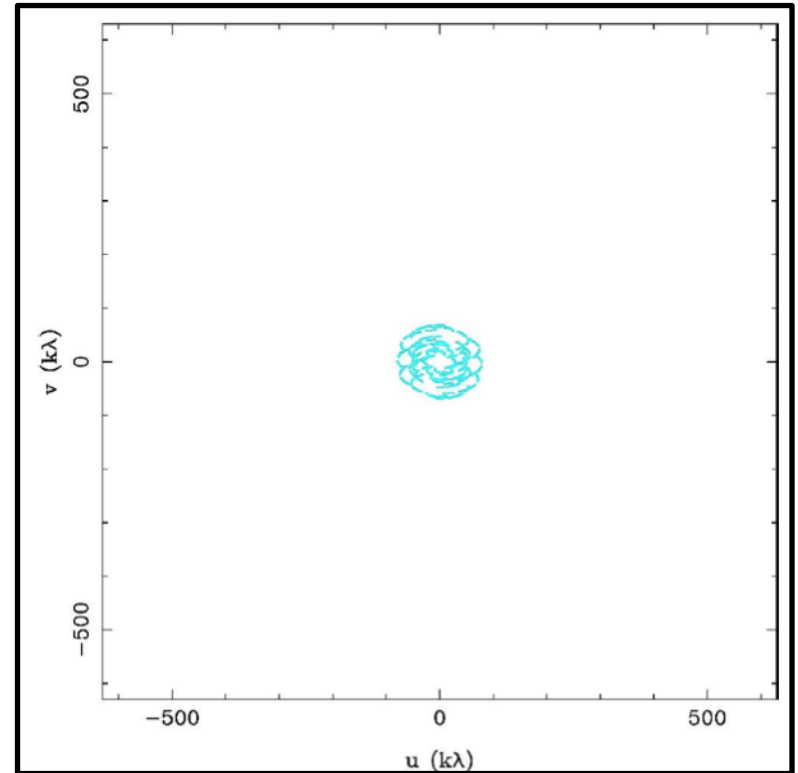
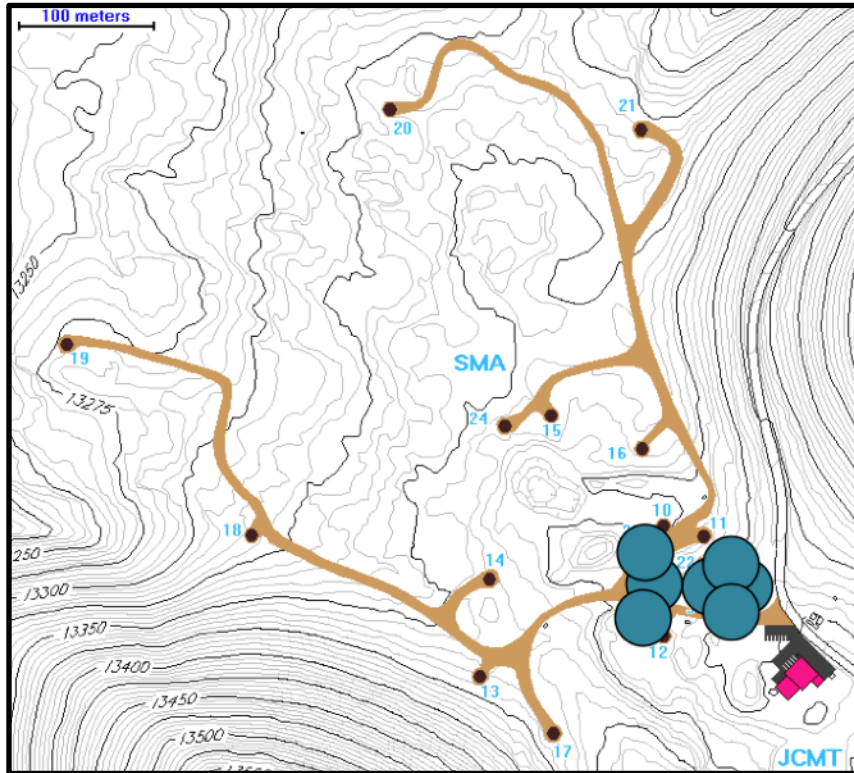

Compact SMA configuration

(compact baselines)

345 GHz, DEC = +22

(u,v) Plane Sampling

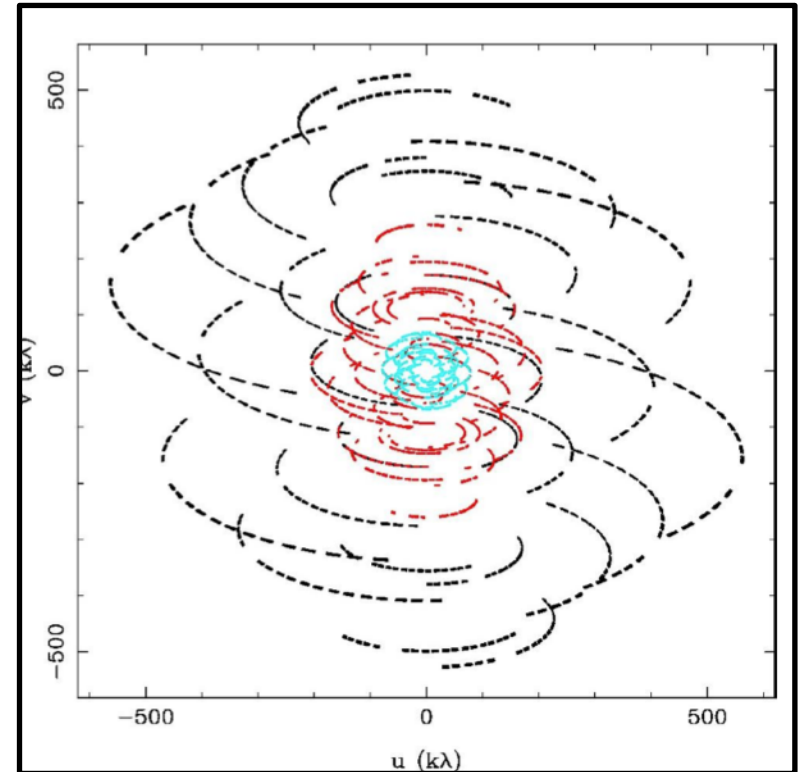
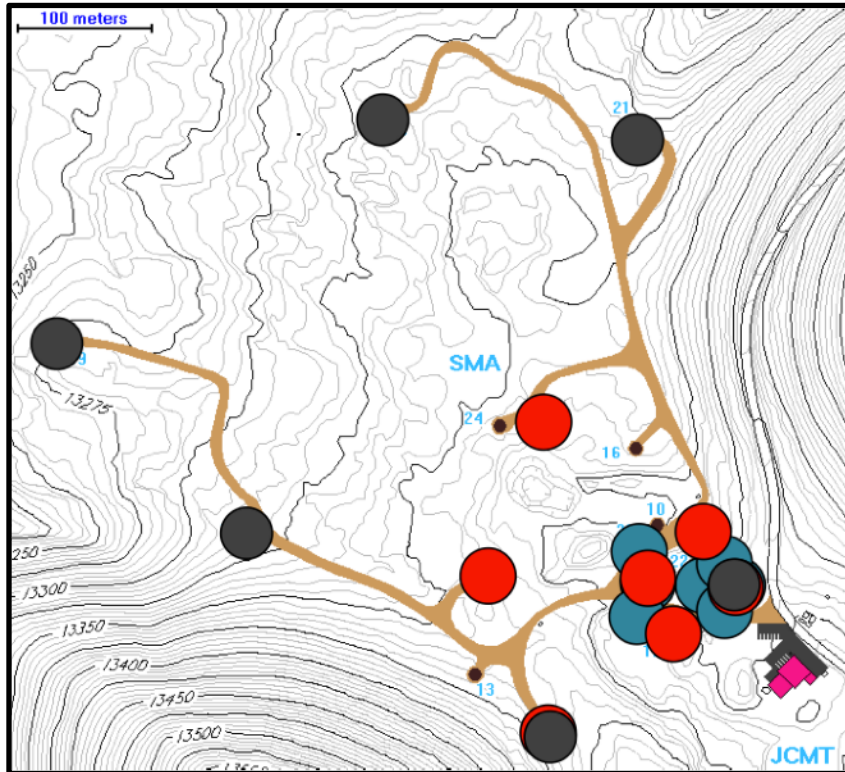

Combine multiple configurations to get the most complete coverage of the (u,v) plane

Characteristic Angular Scales

Angular resolution of telescope array:

$$\sim \lambda/B_{\max} \quad (B_{\max} = \text{longest baseline})$$

Maximum angular scale:

$$\sim \lambda/B_{\min} \quad (B_{\min} = \text{shortest distance between antennas})$$

Field of view (FOV):

$$\sim \lambda/D \quad (D = \text{antenna diameter})$$

*Sources more extended than the FOV can be observed using multiple pointing centers in a mosaic

An interferometer is sensitive to a range of angular sizes: $\lambda/B_{\max} < \theta < \lambda/B_{\min}$



Primer video on Largest Angular Scale: <https://www.youtube.com/watch?v=9iDNq82t7gs>

Characteristic Angular Scales: M100

ALMA 12m

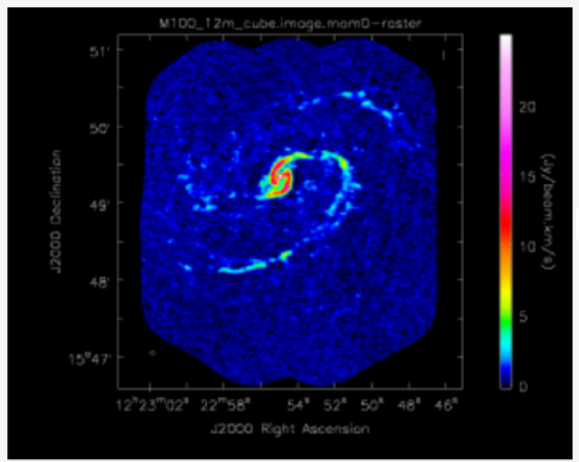

ACA 7m

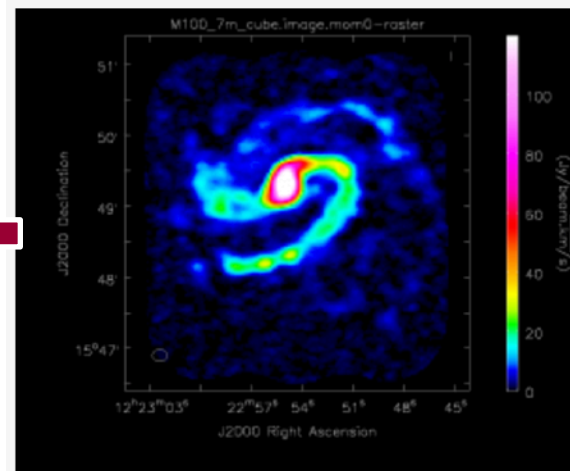

Combined

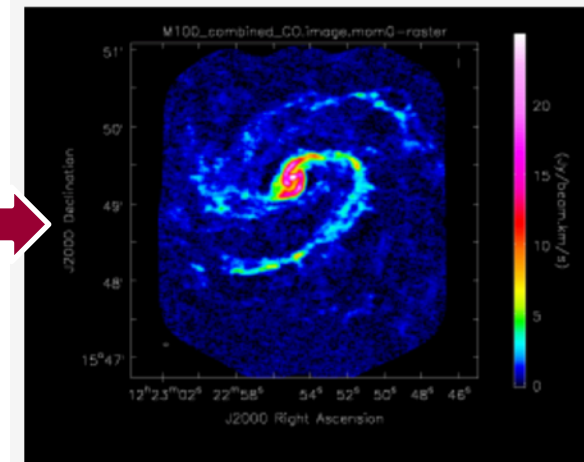

ALMA 12m shows smaller spatial scales (denser, clumpier emission)

ACA 7m data shows larger spatial scales (diffuse, extended emission)

To get both — you need a combined image!

Interferometry: Spatial Scales

- The **sensitivity** is given by the number of antennas times their area
- The **field of view** is given by the beam of a single antenna (corresponding to the resolution for a single dish telescope or the primary beam)
- The **resolution** is given by the largest distance between antennas (called the synthesized beam)
- The **largest angular scale** that can be imaged is given by the shortest distance between antennas

Angular Scales – A Proposal Tip!

Interferometers act as spatial filters - shorter baselines are sensitive to larger targets, so remember ...

Spatial scales larger than the smallest baseline cannot be imaged

Spatial scales smaller than the largest baseline cannot be resolved

Config.	L _{max}	Band	1	3	4	5	6	7	8	9	10
		Freq. (GHz)	40	100	150	185	230	345	460	650	870
	L _{min}										
7-m	45 m	θ_{res} (arcsec)	31.5	12.5	8.35	6.77	5.45	3.63	2.72	1.93	1.44
	9 m	θ_{MRS} (arcsec)	167	66.7	44.5	36.1	29.0	19.3	14.5	10.3	7.67
C-1	161 m	θ_{res} (arcsec)	8.45	3.38	2.25	1.83	1.47	0.98	0.74	0.52	0.39
	15 m	θ_{MRS} (arcsec)	71.2	28.5	19.0	15.4	12.4	8.25	6.19	4.38	3.27
C-2	314 m	θ_{res} (arcsec)	5.75	2.30	1.53	1.24	1.00	0.67	0.50	0.35	0.26
	15 m	θ_{MRS} (arcsec)	56.5	22.6	15.0	12.2	9.81	6.54	4.90	3.47	2.59
C-3	500 m	θ_{res} (arcsec)	3.55	1.42	0.94	0.77	0.62	0.41	0.31	0.22	0.16
	15 m	θ_{MRS} (arcsec)	40.5	16.2	10.8	8.73	7.02	4.68	3.51	2.48	1.86
C-4	784 m	θ_{res} (arcsec)	2.30	0.92	0.61	0.50	0.40	0.27	0.20	0.14	0.11
	15 m	θ_{MRS} (arcsec)	28.0	11.2	7.50	6.08	4.89	3.26	2.44	1.73	1.29
C-5	1.4 km	θ_{res} (arcsec)	1.38	0.55	0.36	0.30	0.24	0.16	0.12	0.084	0.063
	15 m	θ_{MRS} (arcsec)	16.8	6.70	4.47	3.62	2.91	1.94	1.46	1.03	0.77
C-6	2.5 km	θ_{res} (arcsec)	0.78	0.31	0.20	0.17	0.13	0.089	0.067	0.047	0.035
	15 m	θ_{MRS} (arcsec)	10.3	4.11	2.74	2.22	1.78	1.19	0.89	0.63	0.47
C-7	3.6 km	θ_{res} (arcsec)		0.21	0.14	0.11	0.092	0.061	0.046	0.033	0.024
	64 m	θ_{MRS} (arcsec)		2.58	1.72	1.40	1.12	0.75	0.56	0.40	0.30
C-8	8.5 km	θ_{res} (arcsec)		0.096	0.064	0.052	0.042	0.028	0.021	0.015	0.011
	110 m	θ_{MRS} (arcsec)		1.42	0.95	0.77	0.62	0.41	0.31	0.22	0.16

From the ALMA Cycle 10 Proposal Guide



Implications of (u,v) Coverage

What does it mean if our (u,v) coverage is not complete?

Missing
High Spatial
Frequencies

V(u,v) amplitude

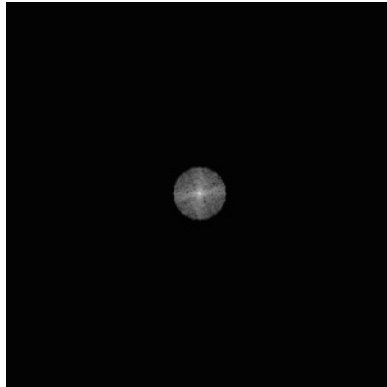

V(u,v) phase

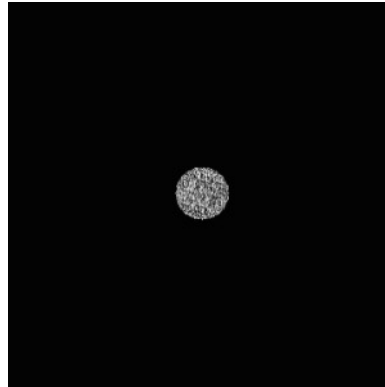

FT
→

T(x,y)



Missing Low
Spatial
Frequencies

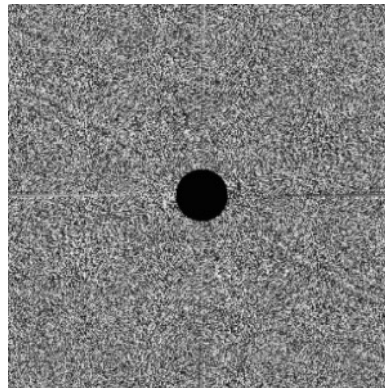
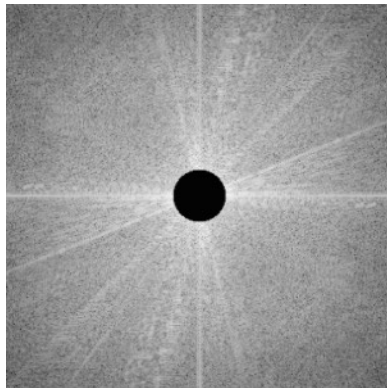

FT
→

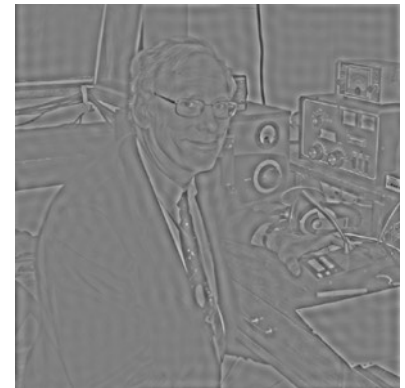

Sampling Function

Each antenna pair samples only one spot; the array cannot sample the entire Fourier/uv domain resulting in an **imperfect image**

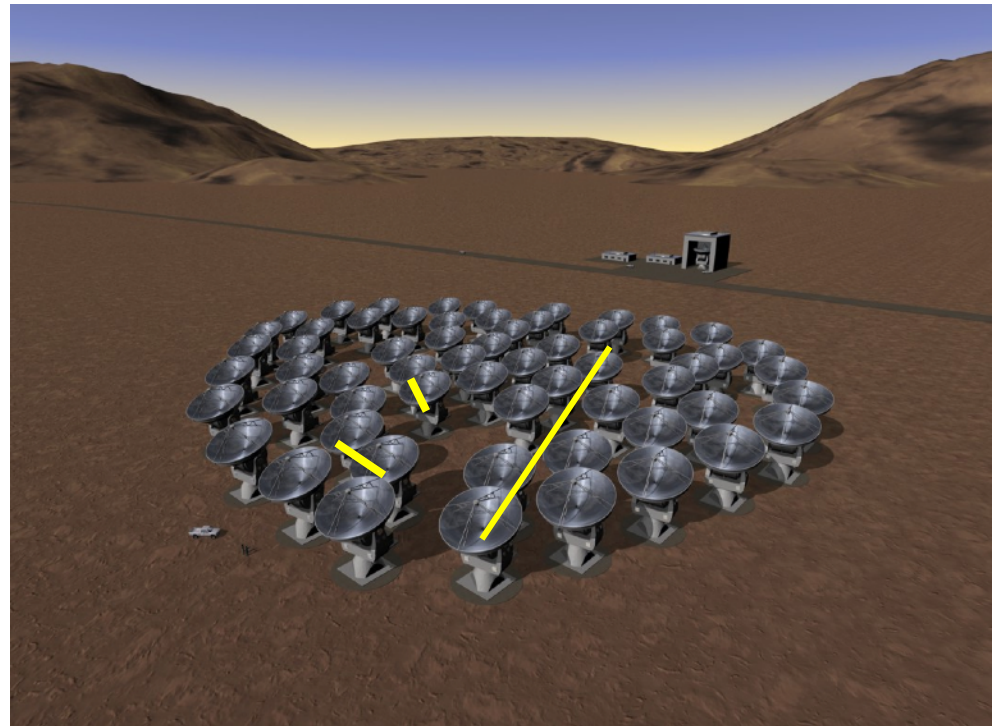
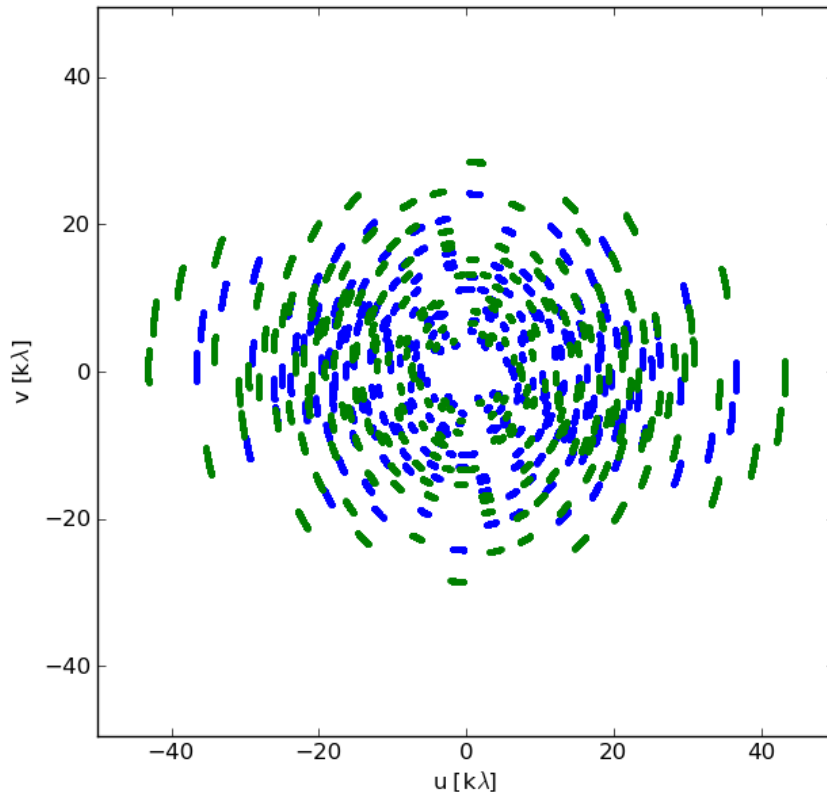

Small uv-distance: short baselines (measure extended emission)

Long uv-distance: long baselines (measure small scale emission)

Orientation of baseline also determines orientation in the uv-plane

uv coverage: why the central hole?

- The central hole in the sampling of the uv plane arises due to missing **short baselines**
- You can have your antennas only so close together

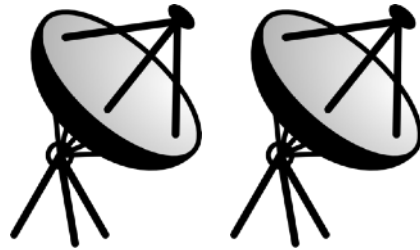

- **Solutions:** We can extrapolate to these shorter spacings after our observations are taken or we can fill in the information with 7m observations or ultimately single dish data.

The Dirty Beam

$S(u,v)$

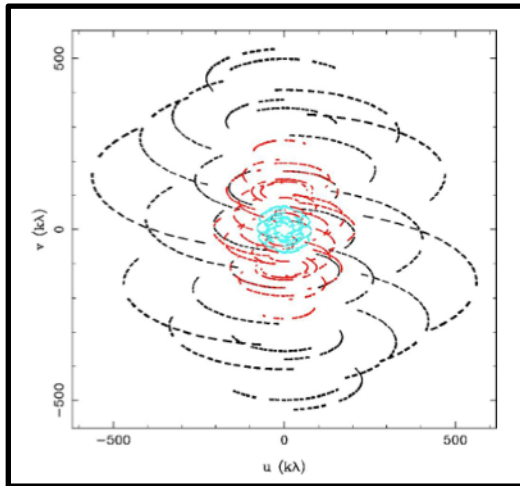

FT \rightarrow

$s(x,y)$
“Dirty Beam”

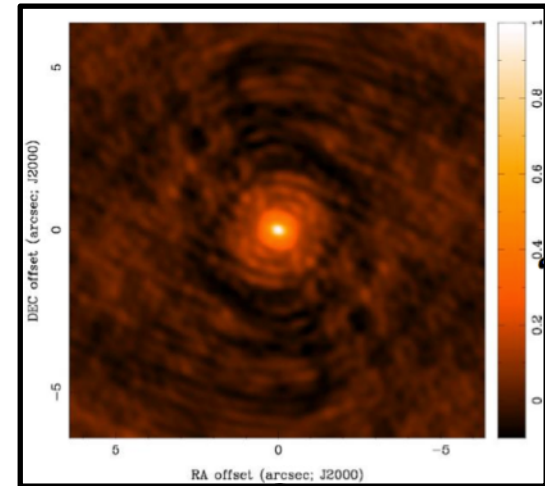

* (Convolution)

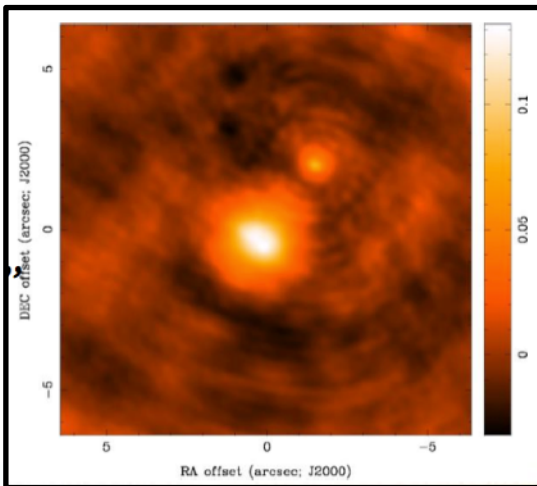

\leftarrow

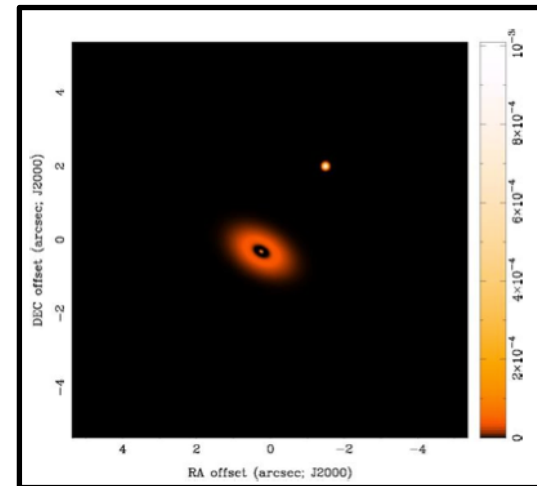

$T_D(x,y)$
“Dirty Image”

$T(x,y)$

Example: Fringe pattern with 2 Antennas (one baseline)

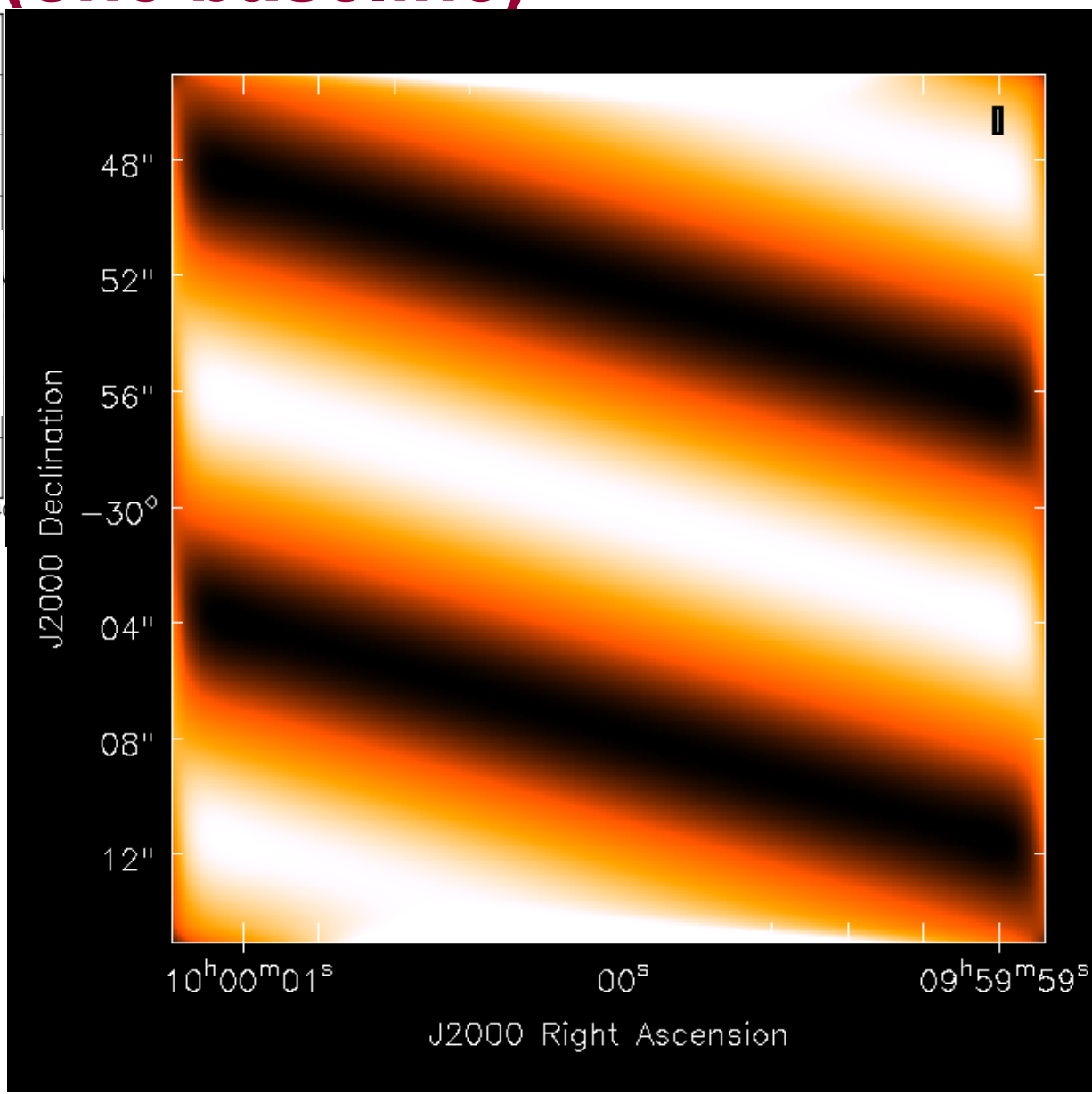
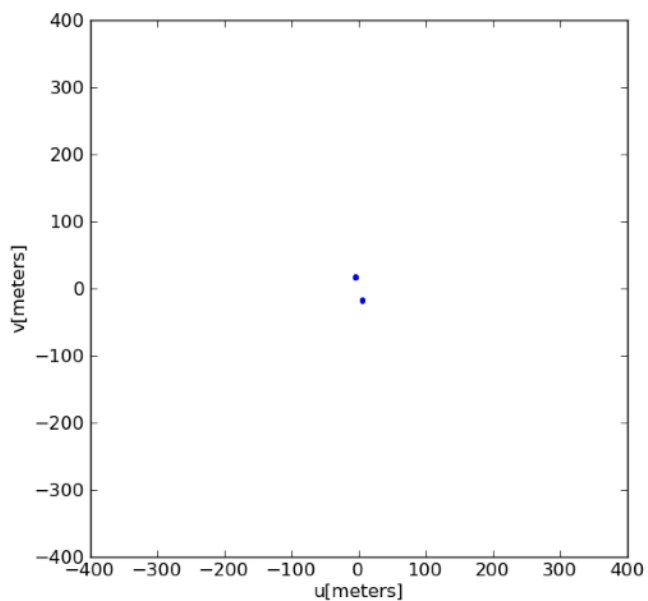
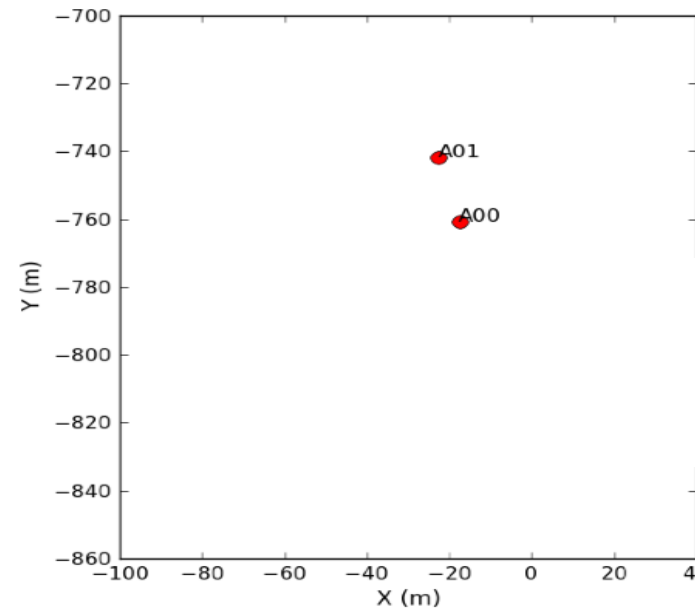

Example: Fringe pattern with 3 Antennas (3 baselines)

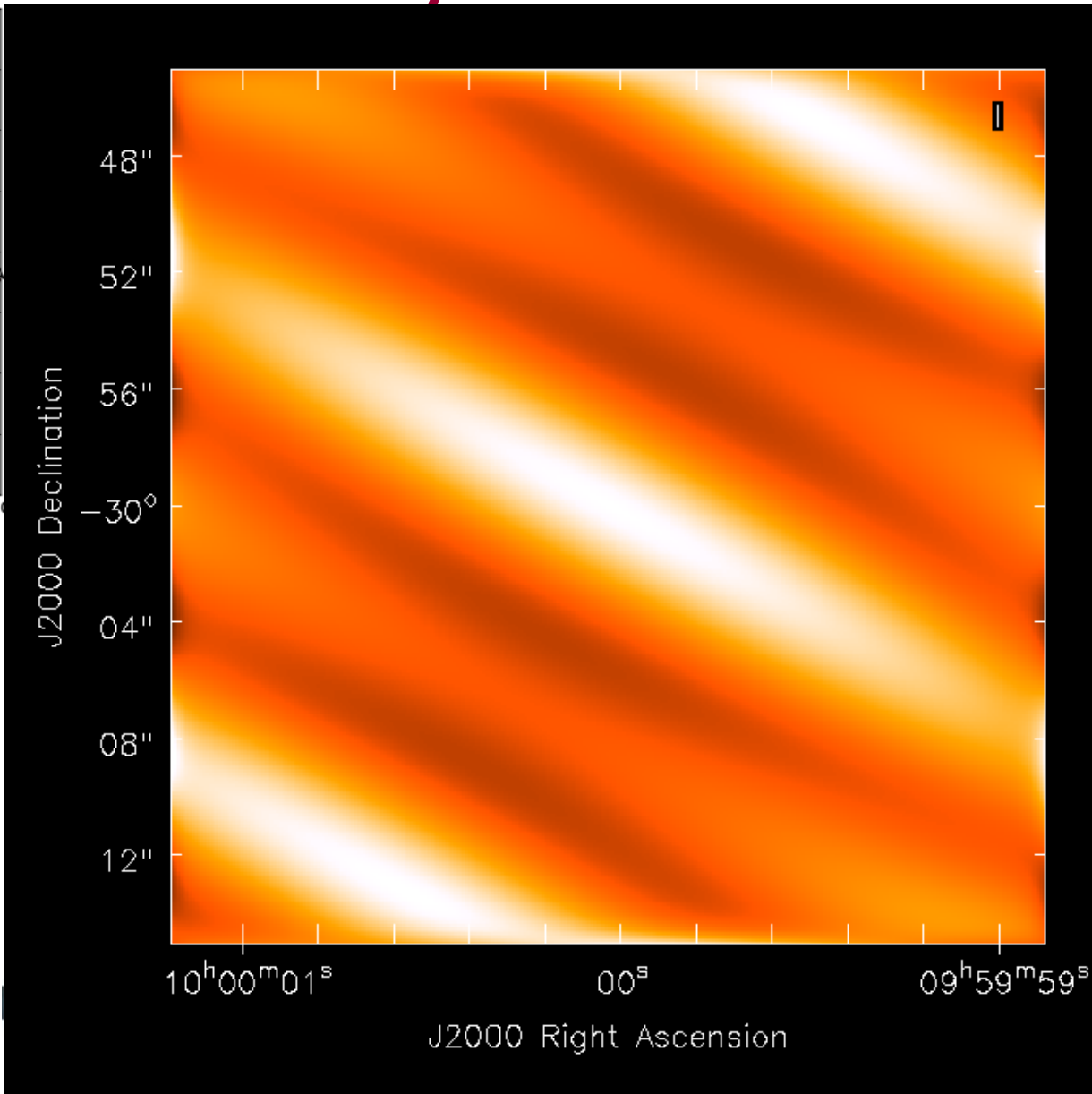
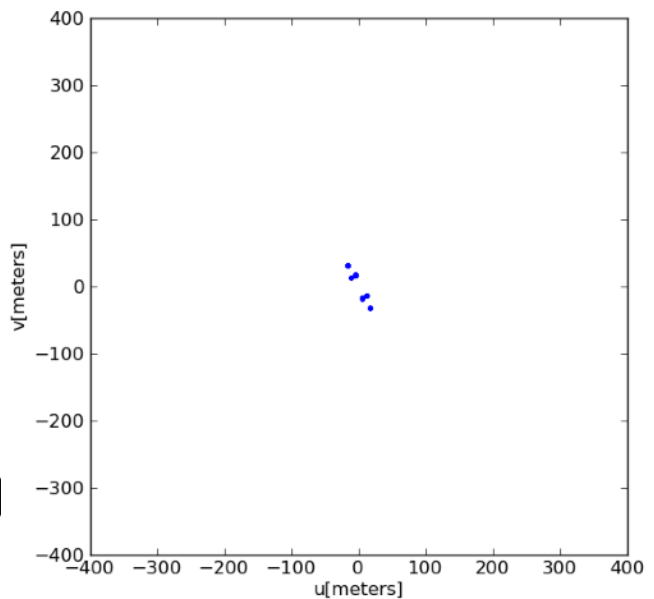
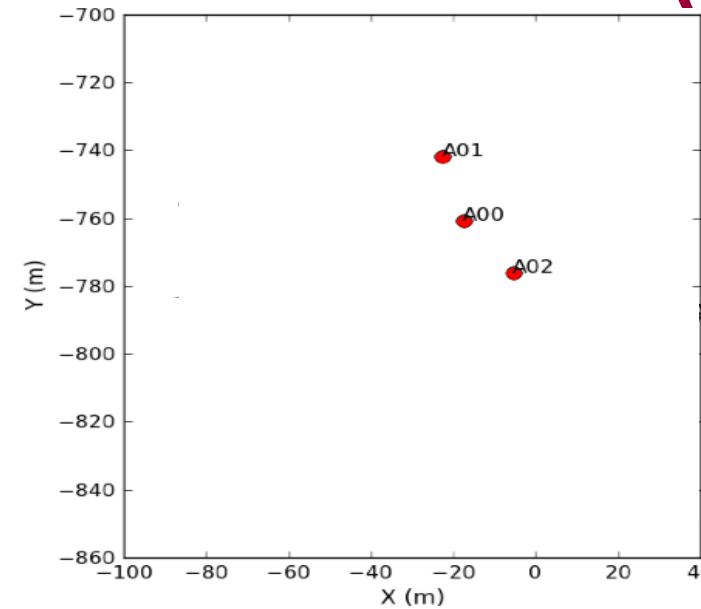

Example: Fringe pattern with 4 Antennas (6 baselines)

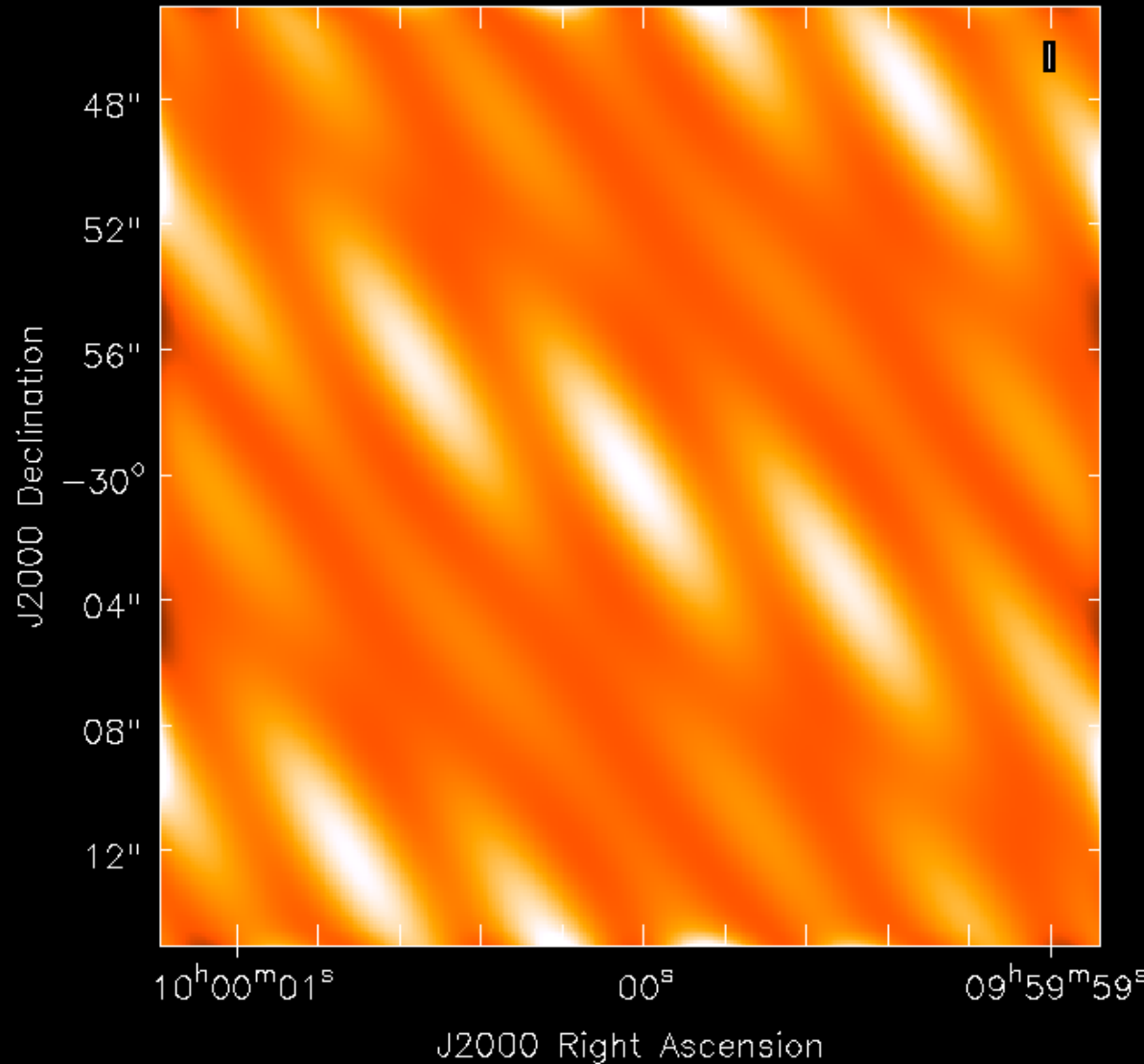
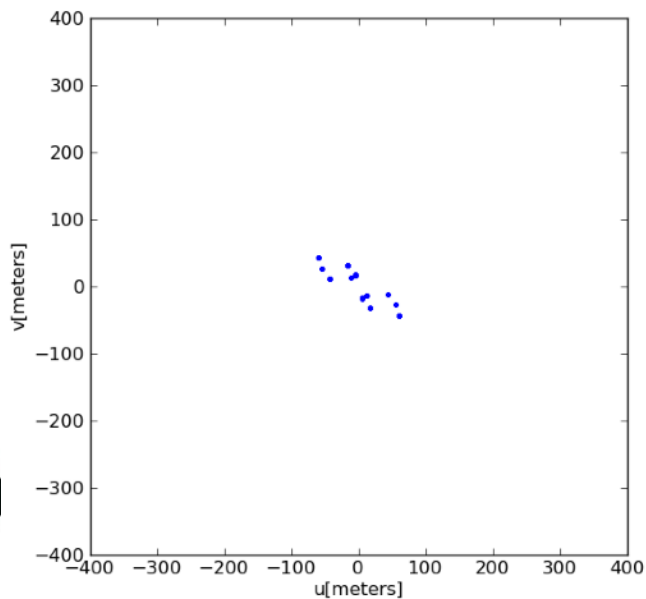
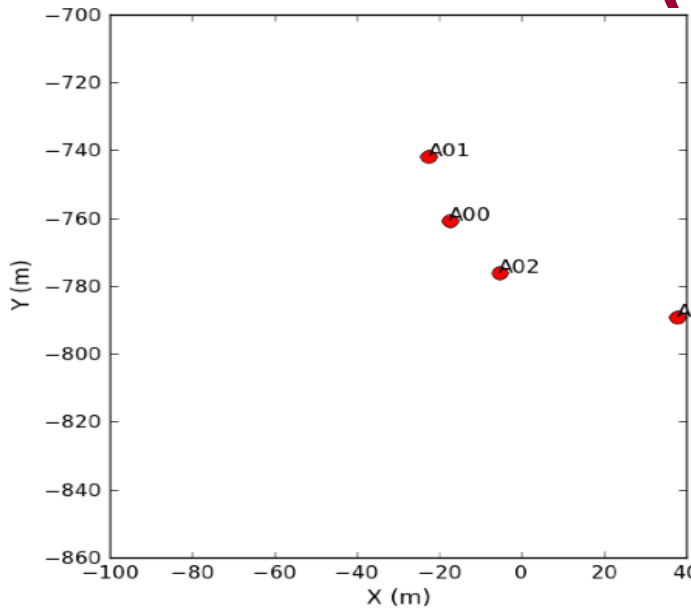

Example: Fringe pattern with 8 Antennas (28 baselines)

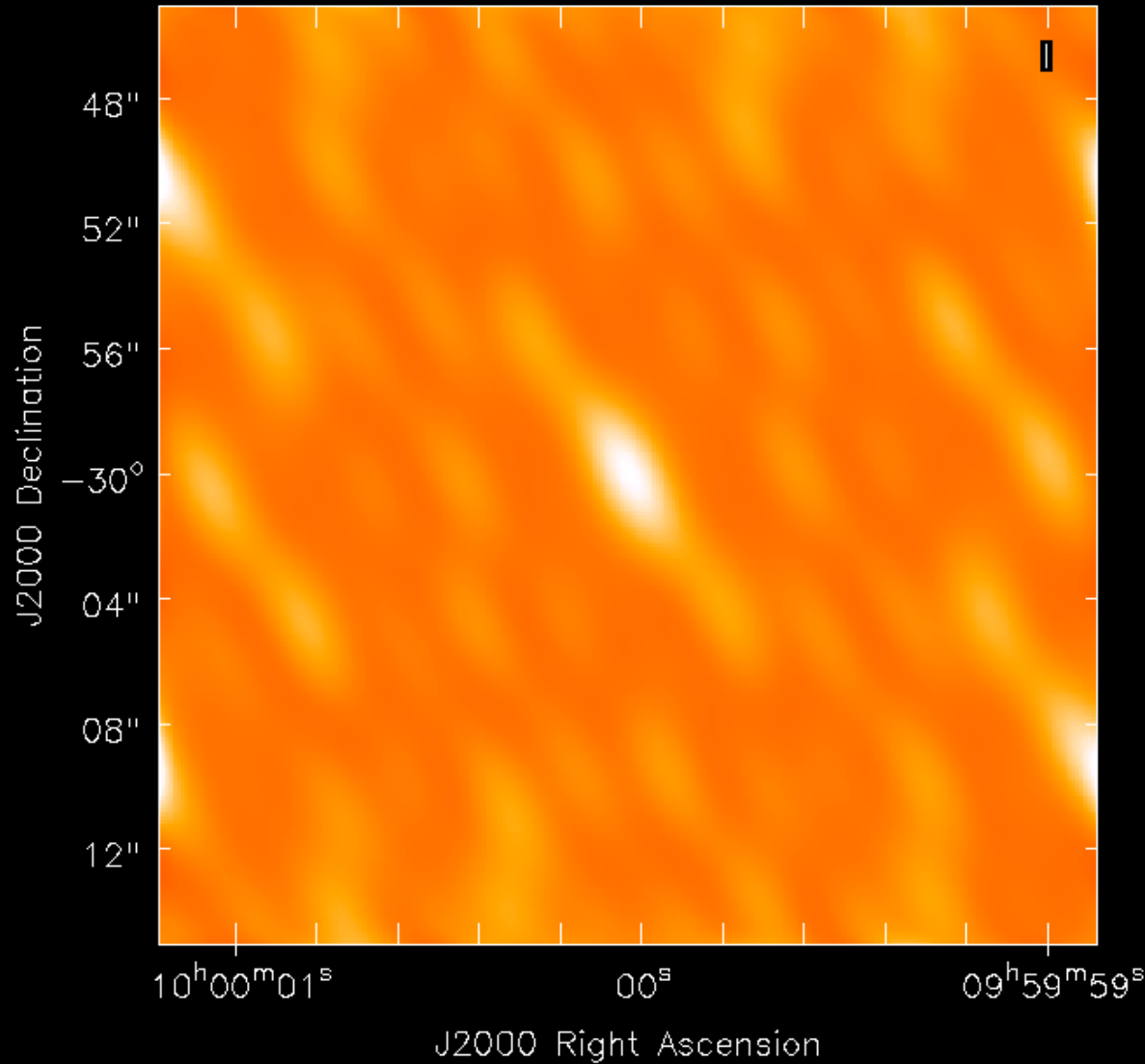
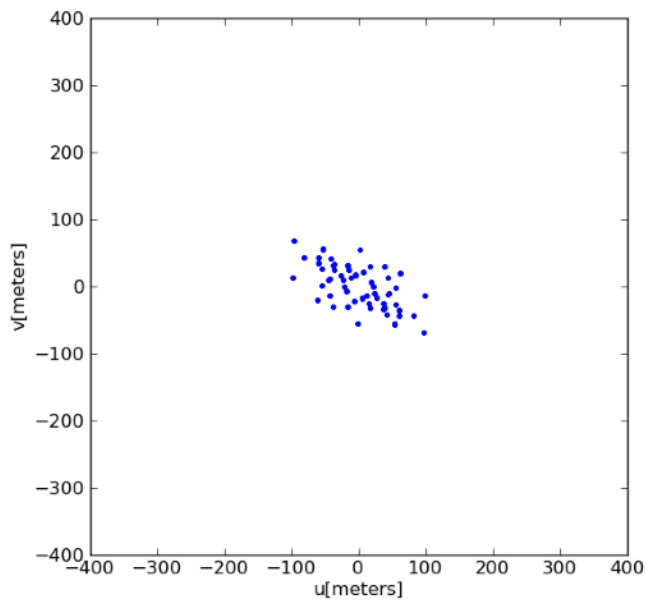
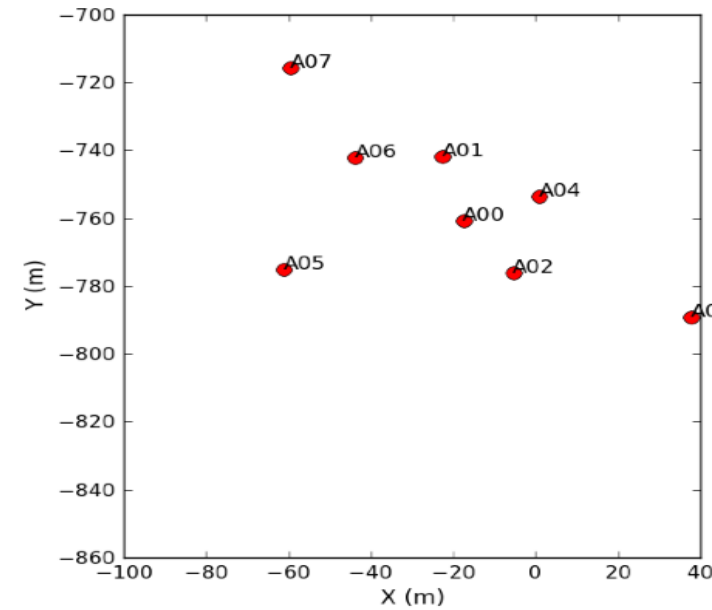

16 Antennas – Compact Configuration

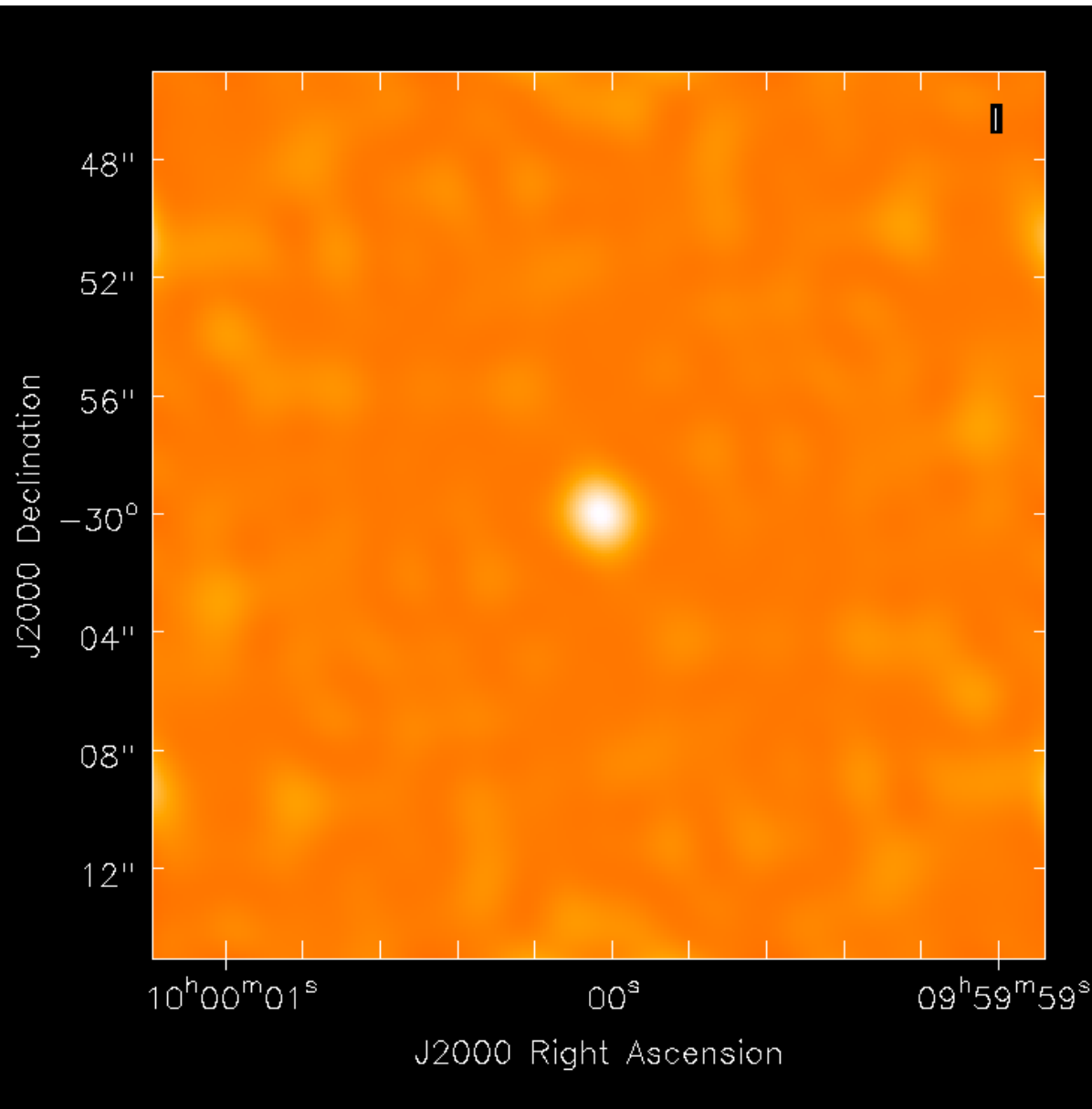
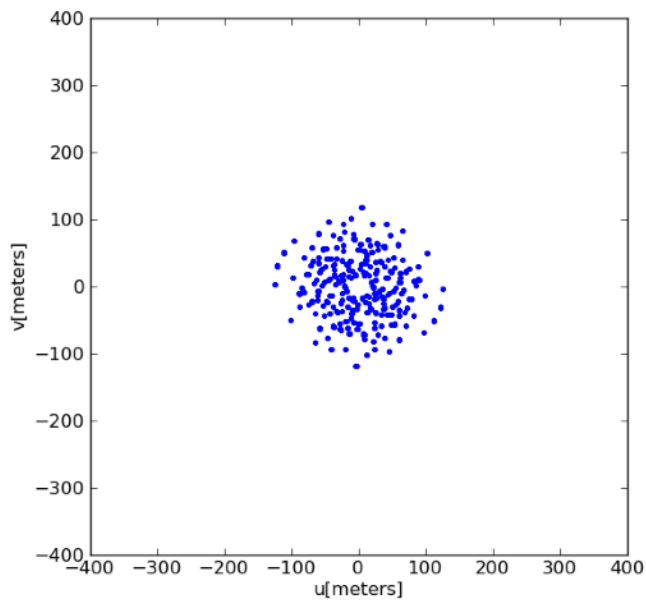
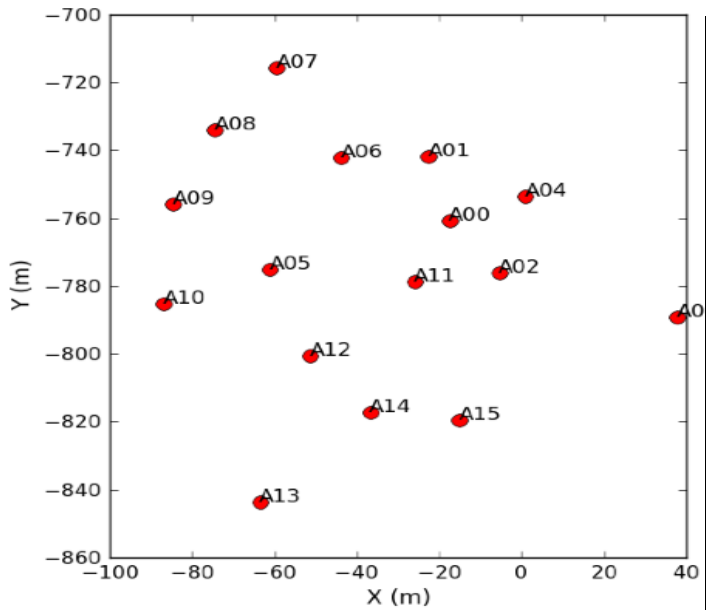

16 Antennas – Extended Configuration

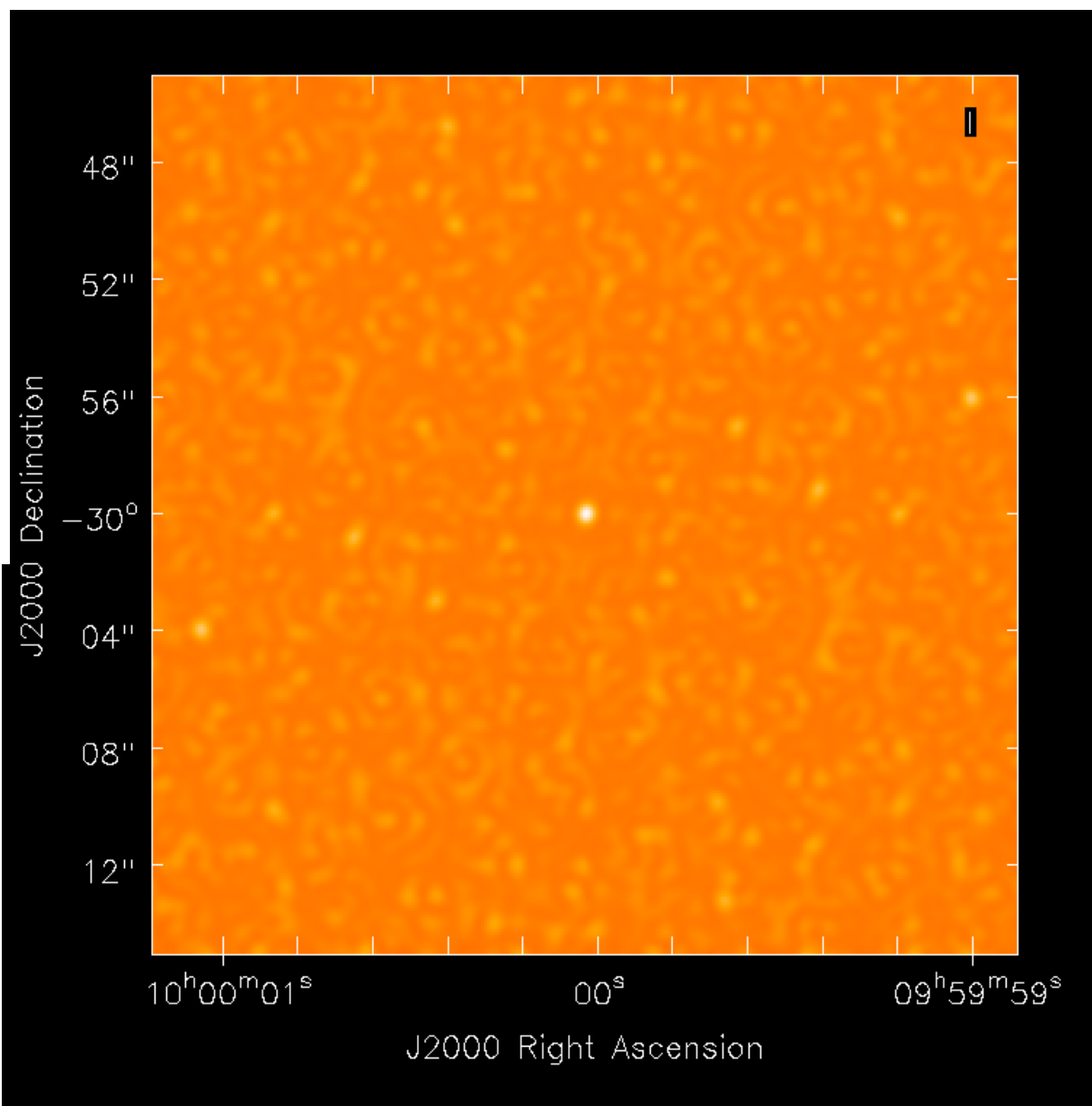
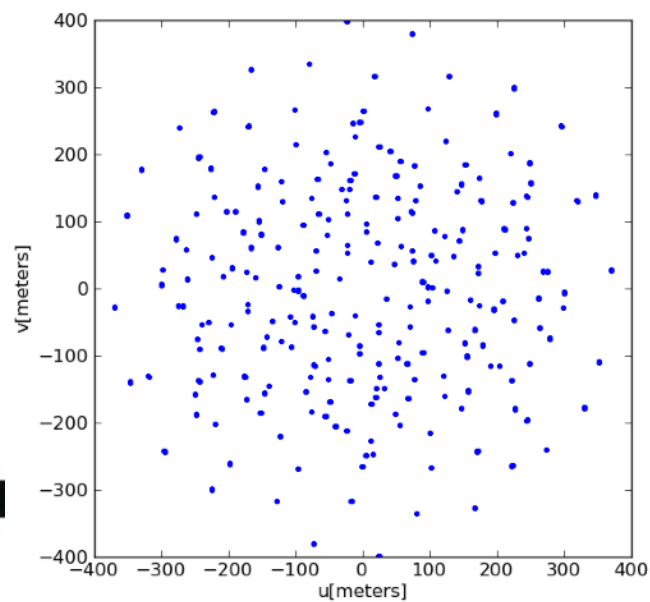
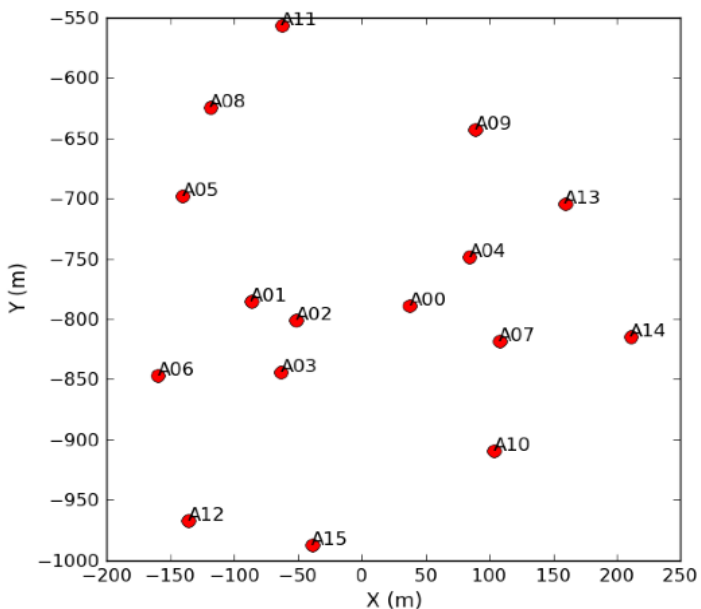

32 Antennas – Instantaneous

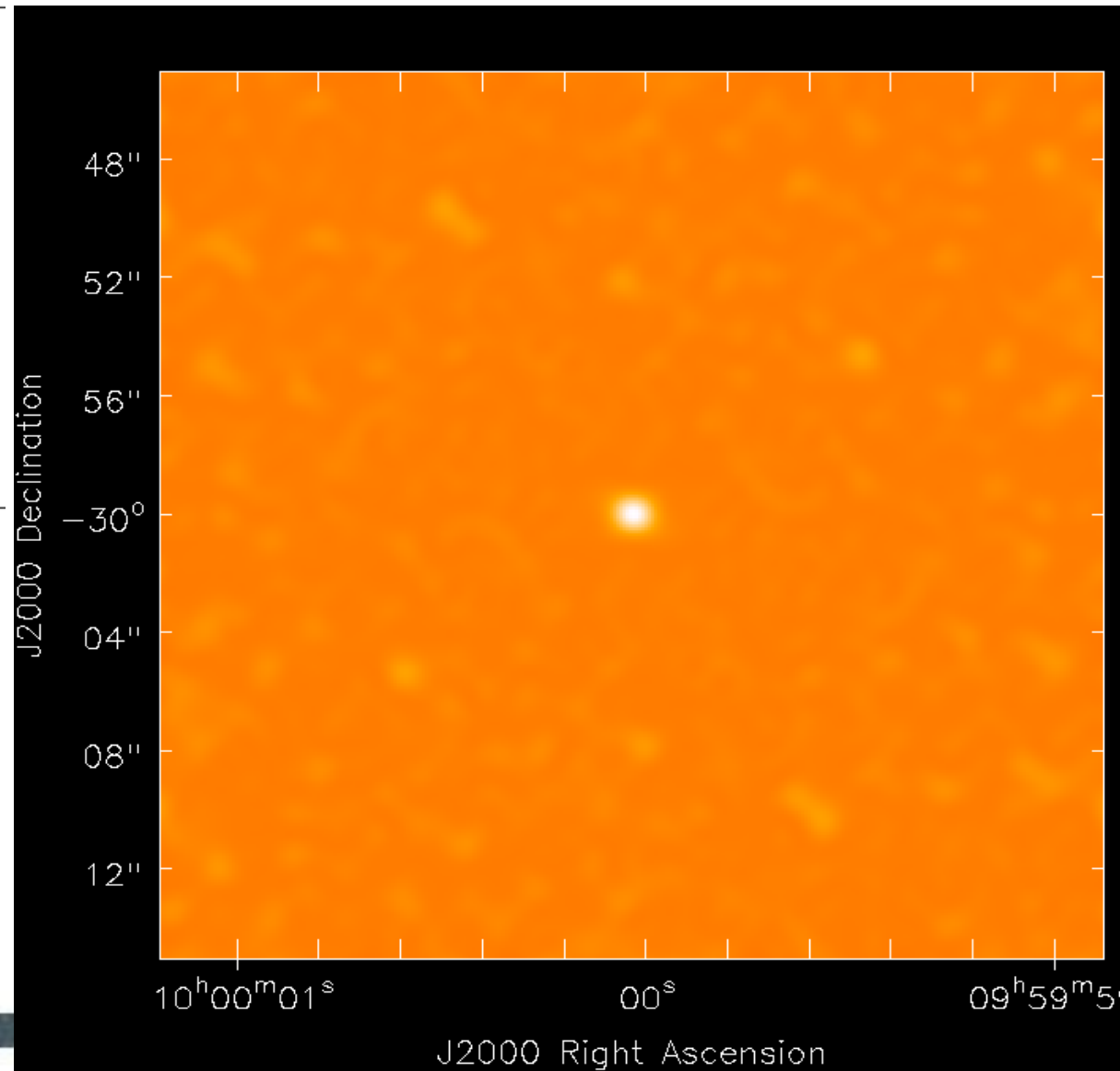
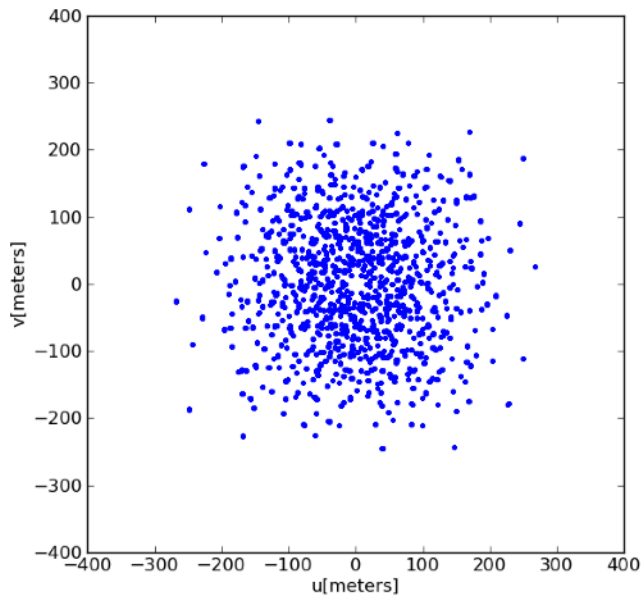
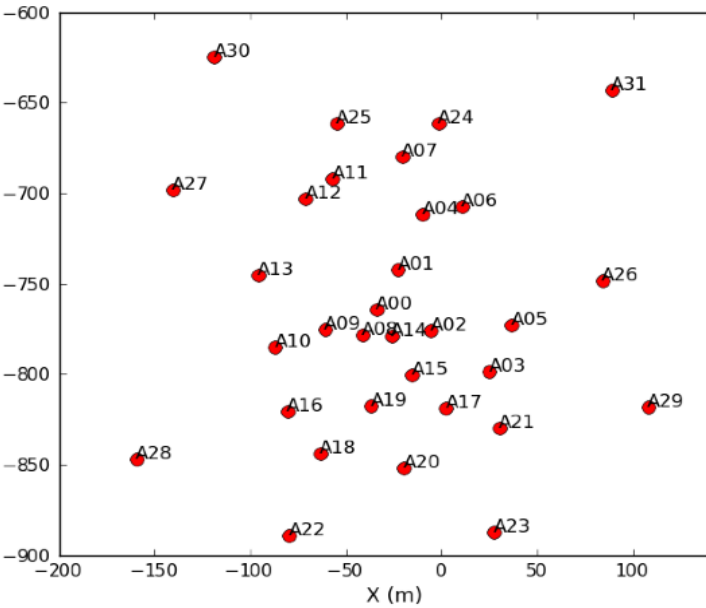

32 Antennas – 8 hours

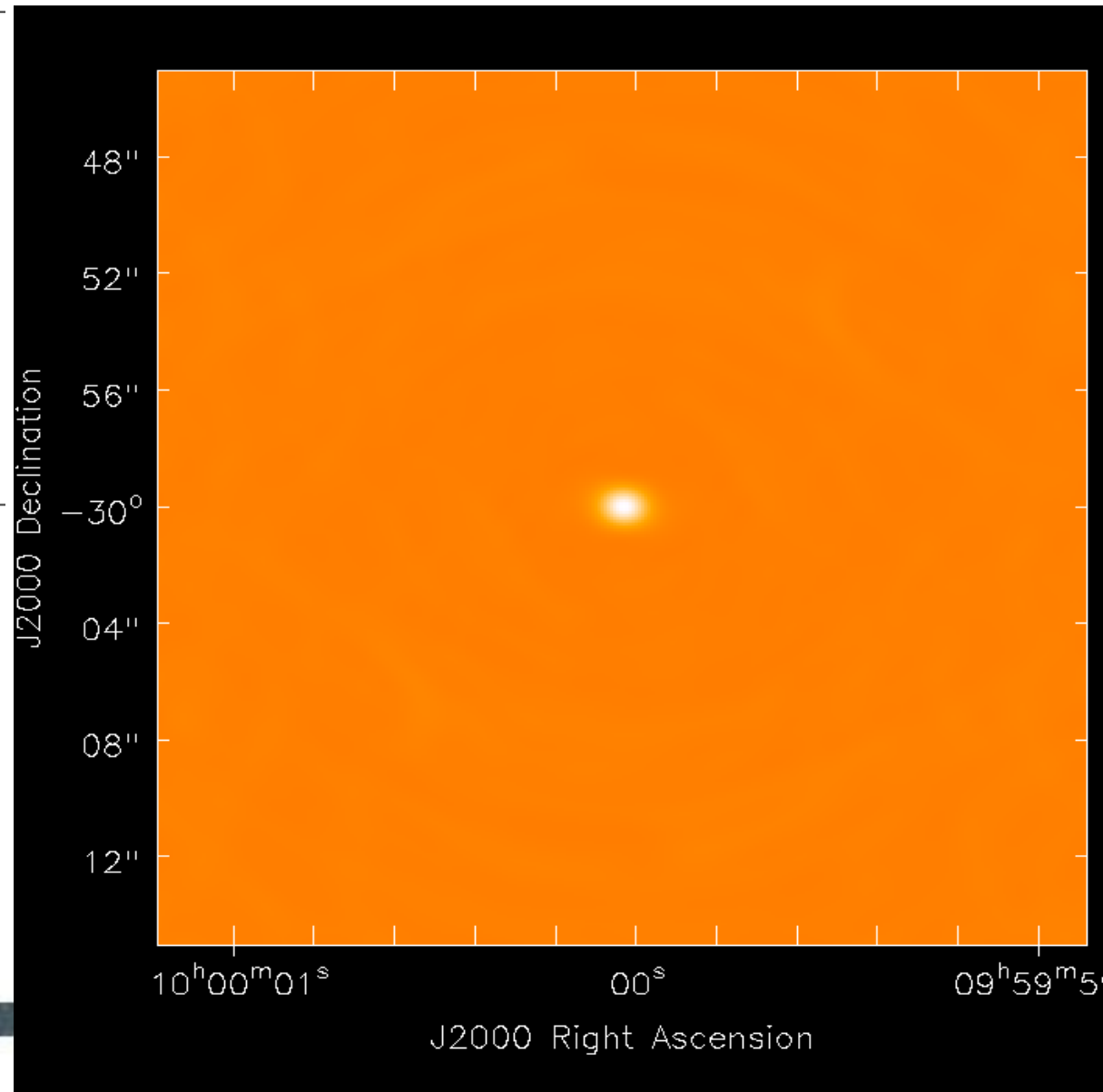
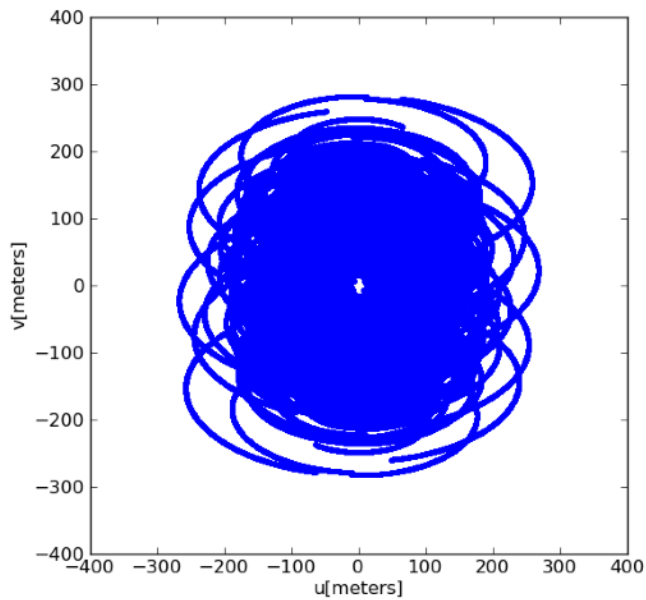
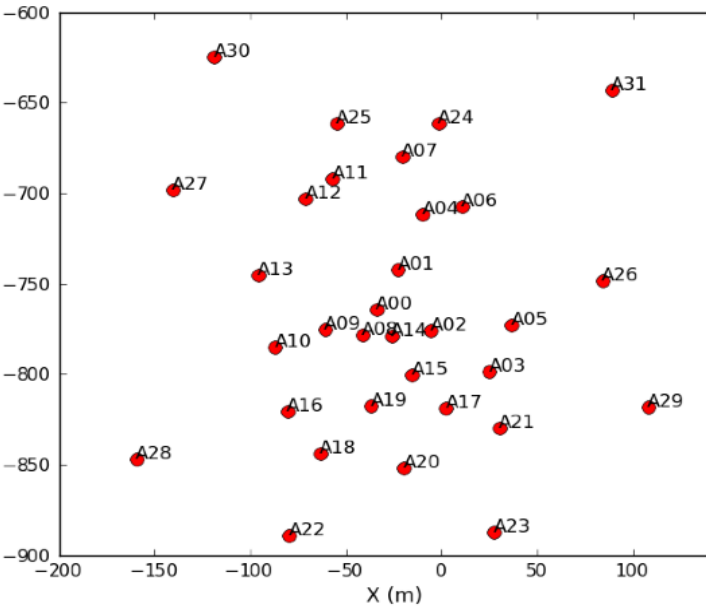

A Brief Word on Calibration

- Interferometers measure visibilities, i.e., the amplitude and phase of the cross-correlated signals between pairs of antennas, as a function of time and frequency.
- We calibrate these data by determining the complex gains (amplitude and phase), the frequency response (bandpass) and flux scale for each antenna.

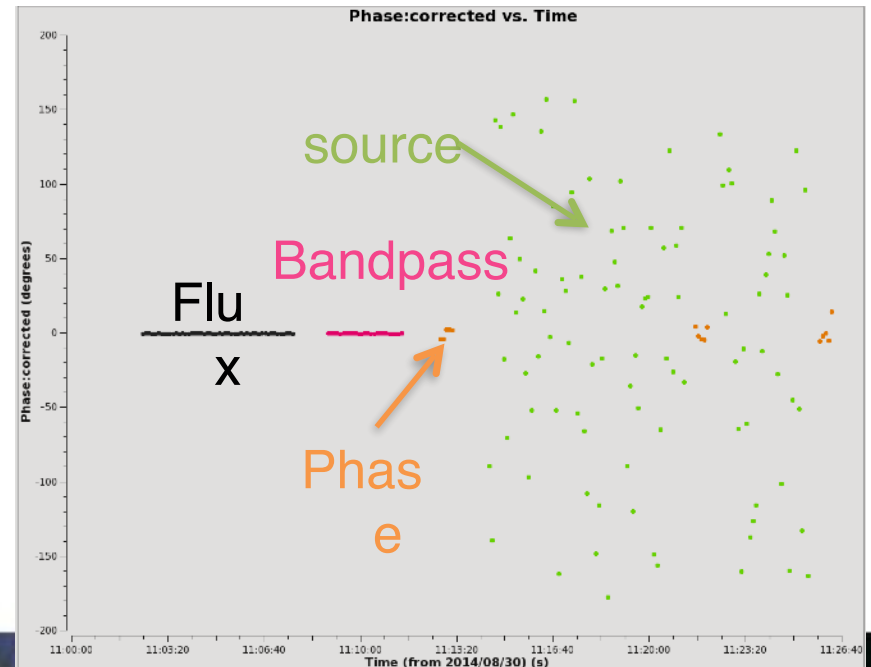
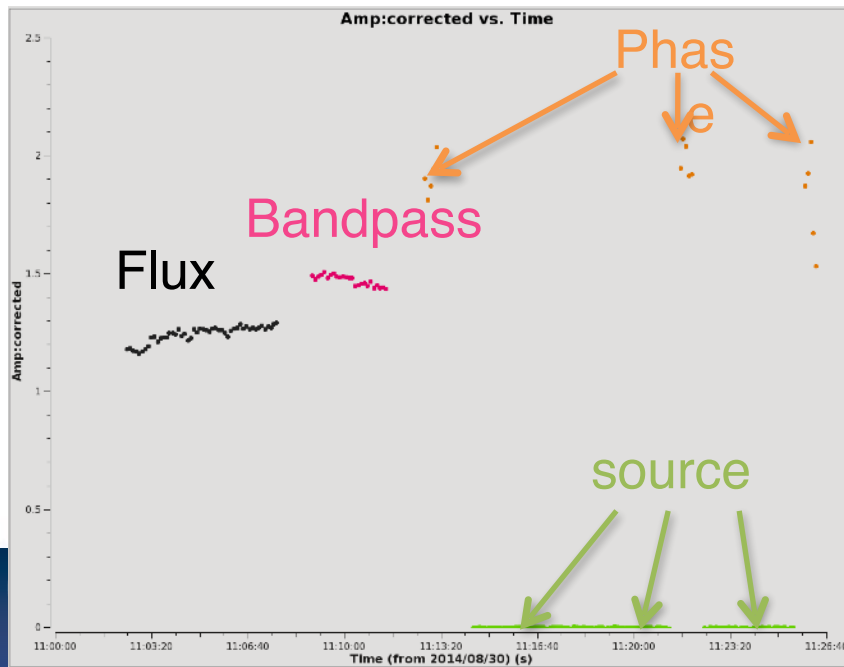

A Brief Word on Calibration

Calibration requirements (Handled by ALMA):

Gain (phase) calibrator

Bright quasar near science target

Solves for atmospheric and instrumental variations with time

Bandpass calibrator

Bright quasar

Fixes instrumental effects and variations vs frequency

Absolute flux calibrator

Solar system object or quasar

Used to scale relative amplitudes to absolute value

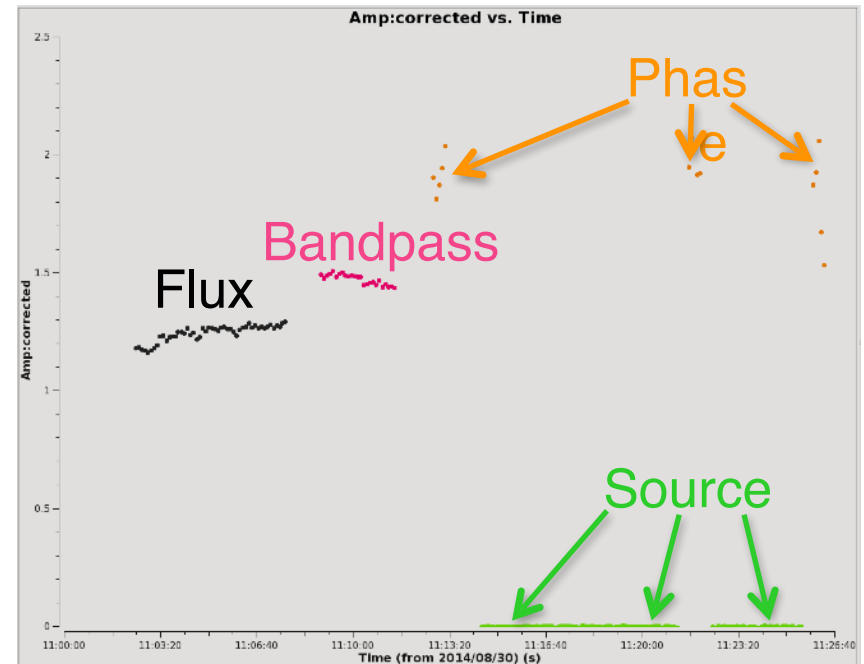

Calibration Process

Calibration is the effort to measure and remove the time-dependent and frequency-dependent atmospheric and instrumental variations.

Steps in calibrating interferometric data:

(Note: You don't have to worry about these in your observational set up!)

- Bandpass calibration (correct frequency-dependent telescope response)
- Phase and amplitude gain calibration (remove effects of atmospheric water vapor and correct time-varying phases/amplitudes)
- Set absolute flux scale

Good Future References

Thompson, A.R., Moran, J.M., Swensen, G.W. 2017
“Interferometry and Synthesis in Radio Astronomy”, 3rd edition
(Springer)

<http://www.springer.com/us/book/9783319444291>

Perley, R.A., Schwab, F.R., Bridle, A.H. eds. 1989 ASP Conf.
Series 6 “Synthesis Imaging in Radio Astronomy” (San
Francisco: ASP)

www.aoc.nrao.edu/events/synthesis

IRAM Interferometry School proceedings

www.iram.fr/IRAMFR/IS/IS2008/archive.html



Good Future References

NRAO Synthesis Imaging Workshop

<http://www.cvent.com/events/17th-synthesis-imaging-workshop/event-summary-0d59eb6cd1474978bce811194b2ff961.aspx>

Examples of UV coverage from Ian Czekala

<https://drive.google.com/file/d/1fy3edrJNATo175WopB49-3mZ7QeZPK5O/view>

NAASC Videos

<https://www.youtube.com/channel/UCwTfillYuUQr4sRc5iSJaRg>





www.nrao.edu
science.nrao.edu

*The National Radio Astronomy Observatory is a facility of the National Science Foundation
operated under cooperative agreement by Associated Universities, Inc.*

